

SYSTEM MANUAL
Remote Control System

RC-5

HOW TO READ THIS MANUAL

Thank you for selecting the RC-5.

- Please read this System manual carefully, before using this product.
- The specifications and general appearance of the instrument are subject to change without prior notice and without obligation by TOPCON CORPORATION and may differ from those appearing in this manual.
- The content of this manual is subject to change without notice.
- Some of the diagrams shown in this manual may be simplified for easier understanding.
- This manual is protected by copyright and all rights are reserved by TOPCON CORPORATION.
- Except as permitted by Copyright law, this manual may not be copied, and no part of this manual may be reproduced in any form or by any means.
- This manual may not be modified, adapted or otherwise used for the production of derivative works.

Symbols

The following conventions are used in this manual.



: Indicates precautions and important items which should be read before operations.



: Indicates a cross-reference to refer to for additional information.



: Indicates supplementary explanation.



: Indicates an explanation for a particular term or operation.

[DIST] etc. : Indicates softkeys on the total station display.

{ESC} etc. : Indicates operation keys on the total station.

● **POWER** etc. : Indicates Remote Controller LEDs.

Notes regarding manual style

- Except where stated, "PS" or "PS series " means PS-101A/102A/103A/105A, "total station" means PS in this manual.
- Screens and illustrations used in this manual are of PS (with RC handle).
- The Remote Control System adds remote control functions to the total station. Please read this manual in conjunction with the operator's manual for your instrument.
- The content of this system manual is mainly concerned with explaining the operation of the Remote Controller RC-5. For precautions and operating method, please read the operator's manual for your total station or data collector.

- *Bluetooth*[®] is a registered trademark of Bluetooth SIG, Inc.
- All other company and product names featured in this manual are trademarks or registered trademarks of each respective organization.



JSIMA

:This is the mark of the Japan Surveying
Instruments Manufacturers Association.

CONTENTS



- 1. PRECAUTIONS FOR SAFE OPERATION 1
- 2. PRECAUTIONS 3
- 3. LASER SAFETY INFORMATION 6
- 4. ON-DEMAND REMOTE CONTROL FUNCTIONS 7
 - 4.1 Turning Operation Flow 8
 - 4.2 Measurement Flow 9
- 5. SYSTEM CONFIGURATION 12
 - 5.1 Parts of the Remote Controller 12
 - 5.2 System Configuration of the PS 14
 - 5.3 System Configuration of the Remote Controller 15
- 6. SETTINGS FOR THE PS 20
 - 6.1 Settings for *Bluetooth* Communication 20
 - 6.2 Settings for Auto Pointing and Auto Tracking 22
 - 6.3 Performing Turning from the PS 25
 - 6.4 Turning Error 27
- 7. BASIC OPERATION 28
 - 7.1 Using the Battery 28
 - 7.2 Configuring *Bluetooth* Connections to the PS 29
 - 7.3 Button Operations 30
 - 7.4 Communication Status 32
 - 7.5 Calibrating the Electronic Compass 33
- 8. ERROR INDICATIONS 36
- 9. TROUBLESHOOTING 37
- 10. OPTIONAL ACCESSORIES 38
 - 10.1 Power Supply System 40
- 11. SPECIFICATIONS 41
- 12. EXPLANATION 44
 - 12.1 High Accuracy with the 360° Prism 44
- 13. BUTTON OPERATIONS LIST 45
- 14. REGULATIONS 46

1. PRECAUTIONS FOR SAFE OPERATION

For the safe use of the product and prevention of injury to operators and other persons as well as prevention of property damage, items which should be observed are indicated by an exclamation point within a triangle used with WARNING and CAUTION statements in this system manual.

The definitions of the indications are listed below. Be sure you understand them before reading the main text.

Definition of Indication

	WARNING	Ignoring this indication and making an operation error could possibly result in death or serious injury to the operator.
	CAUTION	Ignoring this indication and making an operation error could possibly result in personal injury or property damage.



This symbol indicates items for which caution (hazard warnings inclusive) is urged. Specific details are printed in or near the symbol.



This symbol indicates items which are prohibited. Specific details are printed in or near the symbol.



This symbol indicates items which must always be performed. Specific details are printed in or near the symbol.

General



Warning



Do not use the unit in areas exposed to high amounts of dust or ash, in areas where there is inadequate ventilation, or near combustible materials. An explosion could occur.



Do not perform disassembly or rebuilding. Fire, electric shock, burns, or hazardous radiation exposure could result.



When securing the instrument in the carrying case make sure that all catches, including the side catches, are closed. Failure to do so could result in the instrument falling out while being carried, causing injury.



Caution



When mounting the instrument on the pole, tighten the pole-securing knob securely. Failure to tighten the knob properly could result in the instrument falling off the pole, causing injury.



Do not carry the pole with the tip pointed at other persons. A person could be injured if struck by the shoe.















Keep hands and feet away from the tip of the pole when fixing the pole in the ground. A hand or foot stab wound could result.

-  Do not use the carrying case as a footstool. The case is slippery and unstable so a person could slip and fall off it.

Power Supply

Warning

-  Do not short circuit. Heat or ignition could result.
-  Do not place articles such as clothing on the battery charger while charging batteries. Sparks could be induced, leading to fire.
-  Do not use voltage other than the specified power supply voltage. Fire or electrical shock could result.
-  Do not use batteries other than those designated. An explosion could occur, or abnormal heat generated, leading to fire.
-  Do not use damaged power cords, plugs or loose outlets. Fire or electric shock could result.
-  Do not use power cords other than those designated. Fire could result.
-  Use only the specified battery charger to recharge batteries. Other chargers may be of different voltage rating or polarity, causing sparking which could lead to fire or burns.
-  Do not use the battery, charger or AC (power) cable for any other equipment or purpose. Fire or burns caused by ignition could result.
-  Do not heat or throw batteries into fire. An explosion could occur, resulting in injury.
-  To prevent shorting of the battery in storage, apply insulating tape or equivalent to the terminals. Otherwise shorting could occur resulting in fire or burns.
-  Do not use batteries or the battery charger if wet. Resultant shorting could lead to fire or burns.
-  Do not connect or disconnect power supply plugs with wet hands. Electric shock could result.

Caution

-  Do not touch liquid leaking from batteries. Harmful chemicals could cause burns or blisters.

Bluetooth wireless technology



Warning



Do not use within the vicinity of hospitals. Malfunction of medical equipment could result.



Use the instrument at a distance of at least 22 cm from anyone with a cardiac pacemaker. Otherwise, the pacemaker may be adversely affected by the electromagnetic waves produced and cease to operate as normal.



Do not use onboard aircraft. The aircraft instrumentation may malfunction as a result.



Do not use within the vicinity of automatic doors, fire alarms and other devices with automatic controls as the electromagnetic waves produced may adversely affect operation resulting in an accident.

2. PRECAUTIONS

Precautions

- Protect instruments from heavy shocks or vibration.
- Never touch the Remote Controller laser projection port or the total station beam detector. The ability of the system to perform Turning may be adversely affected.
- Turn the power OFF before removing the battery from the Remote Controller.
- Remove the battery when the Remote Controller is not used for long periods.
- Do not allow sand to come into contact with the battery cover catches or the 360° Sliding Prism ATP1S release button. Otherwise sand particles could jam the motion of the catches/button. In the event that sand has jammed the catches/button, hold the unit so that the catches/button are facing downward and operate the catches/button several times until the sand has fallen out.

Maintenance

- Wipe the Remote Controller laser projection port and total station beam detector with the wiping cloth (total station accessory).
- To clean the Remote Controller, lightly moisten a soft cloth in a mild detergent solution. Wring out excess water until the cloth is slightly damp, then carefully wipe the surface of the unit. Do not use any alkaline cleaning solutions, alcohol, or any other organic solvents on the instrument.
- Wipe the slide pole for the ATP1S with tissue paper or a cloth when prism movement along the pole ceases to be smooth. Do not use lubricants.
- Store the instrument in a dry room where the temperature remains fairly constant.
- Check the Remote Controller for proper adjustment periodically to maintain the instrument accuracy.

Precautions concerning water and dust resistance

The Remote Controller conforms to IP55 specifications for waterproofing and dust resistance when the battery cover is closed and connector caps are attached correctly.

- Make sure that moisture or dust particles do not come in contact with the terminals. Operating the instrument with moisture or dust on the terminals may cause damage to the instrument.
- Make sure that the inside of the carrying case and the instrument are dry before closing the case. If moisture is trapped inside the case, it may cause the instrument to rust.

Charging the battery

- The battery (BDC46C) was not charged at the factory. Charge the battery fully before using.

Precautions concerning *Bluetooth* wireless technology

- Use of this technology must be authorized according to telecommunications regulations of the country where the instrument is being used. Contact your local dealer in advance.
☞ "14. REGULATIONS"
- TOPCON CORPORATION is not liable for the content of any transmission nor any content related thereto. When communicating important data, run tests beforehand to ascertain that communication is operating normally.
- Do not divulge the content of any transmission to any third party.

Radio interference when using *Bluetooth* technology

Bluetooth communication with the Remote Controller uses the 2.4 GHz frequency band. This is the same band used by the devices described below.

- Industrial, scientific, and medical (ISM) equipment such as microwaves and pacemakers
- portable premises radio equipment (license required) used in factory production lines etc.
- portable specified low-power radio equipment (license-exempt)
- IEEE802.11b/IEEE802.11g standard wireless LAN devices

The above devices use the same frequency band as *Bluetooth* communications. As a result, using the Remote Controller within proximity to the above devices may result in interference causing communication failure or reduction of transmission speed.

Although a radio station license is not required for this instrument, bear in mind the following points when using *Bluetooth* technology for communication.

- Regarding portable premises radio equipment and portable specified low-power radio equipment:
 - Before starting transmission, check that operation will not take place within the vicinity of portable premises radio equipment or specified low-power radio equipment.
 - In the case that the instrument causes radio interference with portable premises radio equipment, terminate the connection immediately.
 - In the case that the instrument causes radio interference with portable specified low-power radio equipment, move away from said equipment and try again. If the problem persists contact your local dealer.
- When using the Remote Controller in proximity to IEEE802.11b or IEEE802.11g standard wireless LAN devices, turn off all devices not being used.
 - Interference may result, causing transmission speed to slow or even disrupting the connection completely. Turn off all devices not being used.
- Do not use the Remote Controller in proximity to microwaves.
 - Microwave ovens can cause significant interference resulting in communication failure. Perform communication at a distance of 3m or more from microwave ovens.
- Refrain from using the Remote Controller in proximity to televisions and radios.
 - Televisions and radios use a different frequency band to *Bluetooth* communications. However, even if the Remote Controller is used within proximity to the above equipment with no adverse effects with regard to *Bluetooth* communication, moving a *Bluetooth*-compatible device (including the Remote Controller) closer to said equipment may result in electronic noise in sound or images, adversely affecting the performance of televisions and radios.

Precautions regarding transmission

- For best results
 - When using in conjunction with a total station, perform communication within a line-of-sight distance of approximately 300m. The usable range becomes shorter when obstacles block the line of sight, or devices other than total stations, such as PDAs or computers, are used. Wood, glass and plastic will not impede communication but the usable range becomes shorter. Moreover, wood, glass and plastic containing metal frames, plates, foil and other heat shielding elements as well as coatings containing metallic powders may adversely affect *Bluetooth* communication and concrete, reinforced concrete, and metal will render it impossible.
 - Use a vinyl or plastic cover to protect the instrument from rain and moisture. Metallic materials should not be used.
 - The direction of the *Bluetooth* antenna can have adverse effects upon usable range. For best results make sure that the antennas of both the Remote Controller and the companion device are pointing towards one another.

- Reduced range due to atmospheric conditions

The radio waves used by the Remote Controller may be absorbed or scattered by rain, fog, and moisture from the human body with the limit of usable range becoming lower as a result. Similarly, usable range may also shorten when performing communication in wooded areas. Moreover, as wireless devices lose signal strength when close to the ground, perform communication at as high a position as possible.



- TOPCON CORPORATION cannot guarantee that all *Bluetooth* devices are compatible with the Remote Control System.

Exceptions from responsibility

- The user of this product is expected to follow all operating instructions and make periodic checks (hardware only) of the product's performance.
- The manufacturer, or its representatives, assumes no responsibility for results of faulty or intentional usage or misuse including any direct, indirect, consequential damage, or loss of profits.
- The manufacturer, or its representatives, assumes no responsibility for consequential damage, or loss of profits due to any natural disaster, (earthquake, storms, floods etc.), fire, accident, or an act of a third party and/or usage under unusual conditions.
- The manufacturer, or its representatives, assumes no responsibility for any damage (change of data, loss of data, loss of profits, an interruption of business etc.) caused by use of the product or an unusable product.
- The manufacturer, or its representatives, assumes no responsibility for any damage, and loss of profits caused by usage different to that explained in the operator's manual.
- The manufacturer, or its representatives, assumes no responsibility for damage caused by incorrect operation, or action resulting from connecting to other products.

3. LASER SAFETY INFORMATION

Remote Controller is classified as a Class 1 Laser Product according to IEC Standard Publication 60825-1 Ed. 2.0: 2007 and United States Government Code of Federal Regulation FDA CDRH 21CFR Part1040.10 and 1040.11 (Complies with FDA performance standards for laser products except for deviations pursuant to Laser Notice No.50, dated June 24, 2007.)

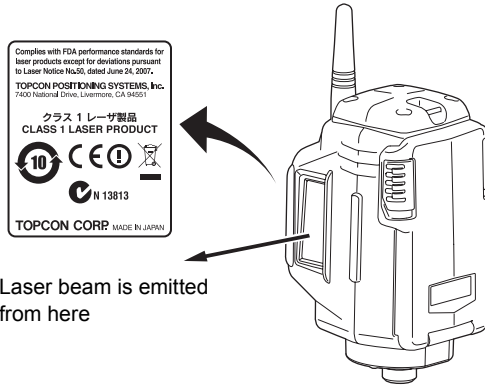

Warning

- Use of controls or adjustments or performance of procedures other than those specified herein may result in hazardous radiation exposure.
- Never point the laser beam at another person. If the laser beam strikes skin or an eye, it could cause serious injury.
- If an eye injury is caused by exposure to the laser beam, seek immediate medical attention from a licensed ophthalmologist.

Caution

- Perform checks at start of work and periodic checks and adjustments with the laser beam emitted under normal conditions.
- When the instrument is not being used, turn OFF the power.
- When disposing of the instrument, destroy the battery connector so that the laser beam cannot be emitted.
- Operate the instrument with due caution to avoid injuries that may be caused by the laser beam unintentionally striking a person in the eye. Avoid setting the instrument at heights at which the path of the laser beam may strike pedestrians or drivers at head height.
- Never point the laser beam at mirrors, windows or surfaces that are highly reflective. The reflected laser beam could cause serious injury.

4. ON-DEMAND REMOTE CONTROL FUNCTIONS

The Remote Control System works as follows. A laser is emitted from the laser projection port on the Remote Controller. The total station rotates until its beam detector receives this beam. In this way the total station is able to detect the position of the Remote Controller. This operation is called "Turning".

With the Remote Control System it is possible for a single operator to perform measurements, unaided, at multiple measurement points.

The Remote Controller incorporates a *Bluetooth* unit which allows simultaneous communication with both the total station and a data collector.

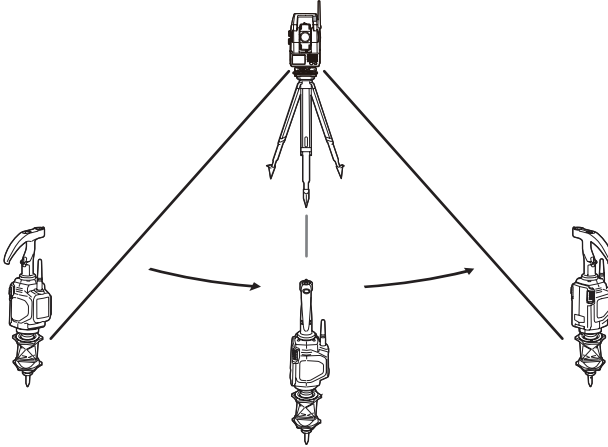

Electronic compass

The Remote Controller is equipped with an electronic compass. Using the Earth's magnetism, this compass can detect the Remote Controller's horizontal angle from magnetic north. The current angle is compared with that for the previous measurement to estimate the direction in which the Remote Controller moved following the previous measurement. By then taking into account the aspect of the telescope the Remote Controller can instruct the total station regarding the quickest rotation direction to the prism.

The onboard electronic compass was calibrated before being shipped from the factory. A function within the compass will automatically perform any necessary calibration in response to changes in the magnetic field.



Auto Pointing and Auto Tracking

When Auto Pointing is performed, the total station analyses the image of the prism in the field of view and moves the telescope to sight the center of this prism. When used in conjunction with the Auto Tracking function, the PS will then "track" the prism as it is moved to the next measurement point. When the prism has been "lost" due to an obstacle in the line-of-sight or operation has been interrupted, the Remote Control System allows you to quickly resume operation where you left off.

4.1 Turning Operation Flow

To perform Turning, follow the procedure below.

 For measurement procedure, see "4.2 Measurement Flow"

1. Point the Remote Controller laser projection port and prism in the direction of the total station and instruct the instrument to start Turning. A laser beam is emitted from the projection port. At the same time, the *Bluetooth* unit (COM 1) relays the instruction to begin Turning.
2. The total station begins to rotate horizontally, searching for the emitted laser beam. If it is not detected by the end of the second rotation, an error occurs.

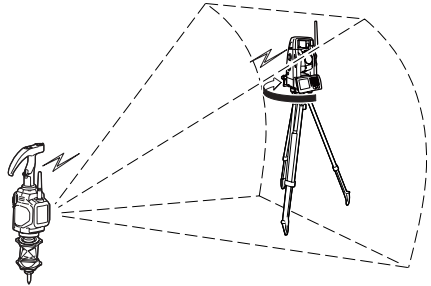

3. Once the position of the horizontal direction has been determined, the total station telescope then begins to rotate along the vertical axis searching for the position of the prism.

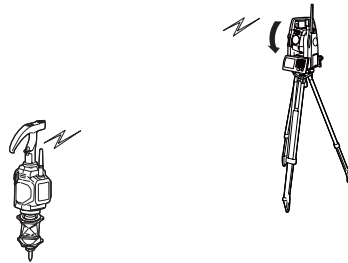

4. Once the position of the vertical direction has been determined an audio sounds and the total station automatically sights the prism in the field of view.

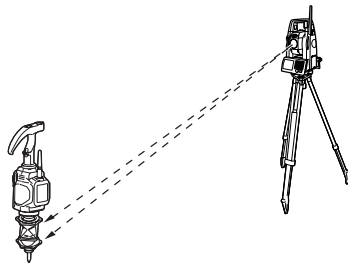

5. The PS tracks a sighted prism as it is moved to the next measurement point when Auto Tracking is set.



- The time limit for Turning is 60 seconds from the start of Turning operation. If the operation exceeds this time limit, an error occurs.



- When Auto Tracking has been selected, the PS will start tracking a moving prism once Turning to that prism has been completed.

4.2 Measurement Flow

This section explains the measurement procedure for a single operator working from the Remote Controller. An operator working alone will need a data collector (available as an optional accessory).





- When reflected laser signal is strong (object with high reflection factor):
If there is an object with a high reflection factor, such as a window or standing water, in the vicinity of the total station/prism, the laser beam may be reflected and Turning operation performed pointing at the object instead of the Remote Controller. In this case the accuracy of measurement results may be adversely affected.
- Fix the pole vertically over the measurement point.



- For communication settings for data collectors etc., see the operator's manual for your respective device.

► PROCEDURE

1. Connect the instruments.
 "5. SYSTEM CONFIGURATION"
2. Switch ON the power to the total station.
3. Set measurement settings for the total station and select prism type.
 "6.2 Settings for Auto Pointing and Auto Tracking"
Prism selection: Operator's Manual
"EDM Settings"

4. Check that PS *Bluetooth* settings are made and the instrument is ready for communication.
 - ☞ "6.1 Settings for Bluetooth Communication"

After completing the total station preparations above, the next step is to prepare the Remote Controller.

5. Press the POWER button  to switch ON the Remote Controller. ● **POWER** is Lit.

6. Fix the pole vertically over the measurement point and point the laser projection port of the Remote Controller roughly in the direction of the total station.

If the distance between the total station and the Remote Controller is over 100m (normal atmospheric conditions)/150m (good atmospheric conditions), set to Far Mode by pressing the FAR button  (● **FAR** is Lit).

 - ☞ For atmospheric conditions, see "7.3.2 Setting Distance Mode"

7. When SEARCH button  is pressed or turning operation is instructed from the data collector, the total station starts turning operation.

8. Send an instruction from the data collector to perform measurement.

Note

- When returned laser signal is weak (object with low reflection factor):
Even if the laser beam received by the total station has been reflected off an unrelated object, or sunlight has entered the beam detector, the total station still attempts to complete the stages of Turning operation as far as Auto Pointing. When the total station judges that the laser beam has not travelled directly from the Remote Controller to the beam detector, this position reading taken in error is nullified and the total station automatically continues Turning operation at the next position. However, the time limit for Turning is 60 seconds from the start of Turning operation and if the operation exceeds this time limit, an error occurs.
- Using the PS guide light when performing Turning operation allows the operator to confirm whether or not the PS has correctly located the Remote Controller laser beam. When a work site contains highly reflective surfaces it is recommended that measurement is performed using the guidelight. If the PS has completed Turning operation pointing at the Remote Controller, both the red and green guide lights are visible from the position of the Remote Controller.
 - ☞ For the total station guide light, see the PS series Operator's Manual



Height difference and slope distance

The maximum measuring range depends on the height difference between the total station and the Remote Controller.

The shaded area in the graph below represents the measurement range when set to Far Mode.

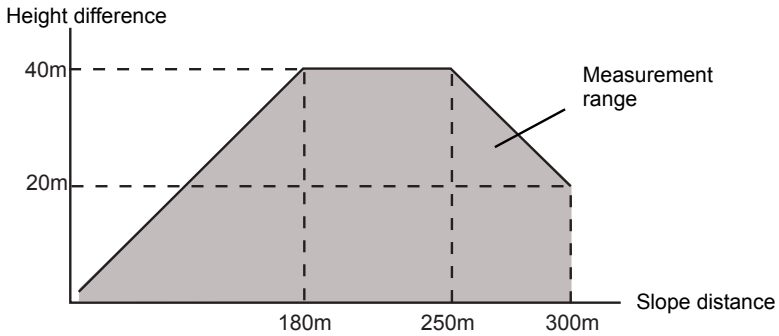

5. SYSTEM CONFIGURATION

5.1 Parts of the Remote Controller

● Remote Controller (RC-5)

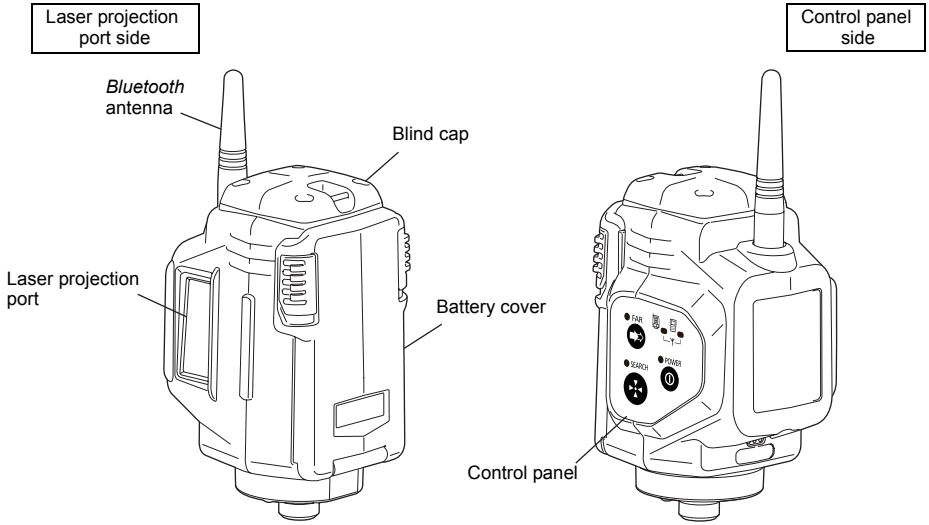

Control panel

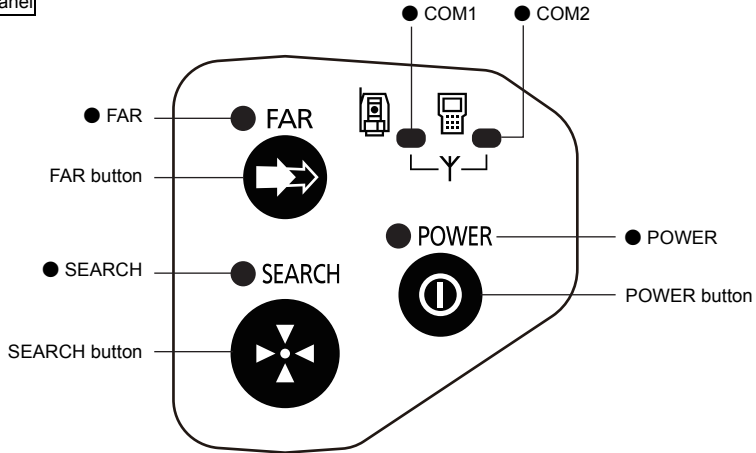

Note

- COM1 is for communication with the total station. COM2 is for communication with the data collector.

● RC-Handle (RC-5RH)

The RC-Handle incorporates a circular level.

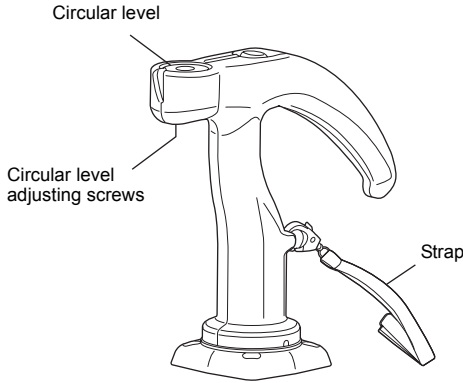

Adjusting the circular level

First attach the RC-Handle and 360° Prism ATP1 to the RC-5, and then attach the RC-5 to the instrument height adapter (AP41) etc. Holding the RC-Handle, keep the instrument level. Check the position of the bubble of the circular level. If the bubble is not off-center, no adjustment is necessary. If the bubble is off-center, perform the following adjustment. First confirm the off-center direction. Use the adjusting pin to loosen the circular level adjustment screw on the side opposite to the direction the bubble is displaced to move the bubble to the center. Adjust the adjusting screws until the tightening tension of the three screws is the same to align the bubble in the middle of the circle.

5.2 System Configuration of the PS

Use a total station that supports the Remote Control System.

PS series

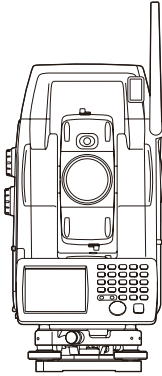

5.3 System Configuration of the Remote Controller

For use with other prism types, contact your local dealer.

● Pin Pole Type

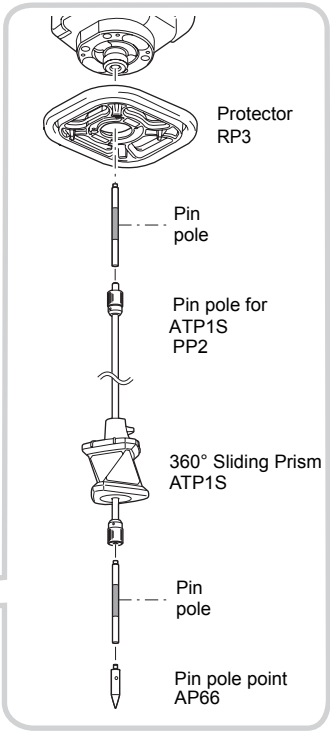
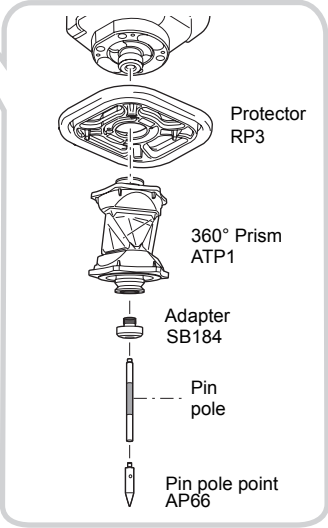
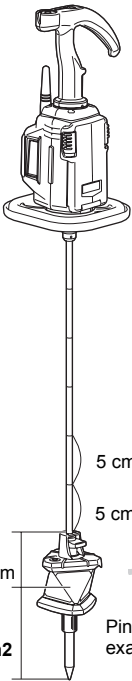
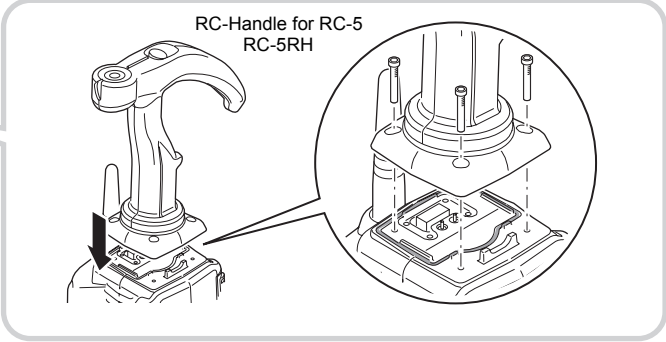
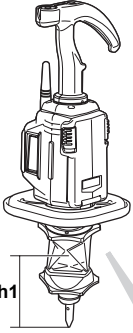

● **Range Pole Type**

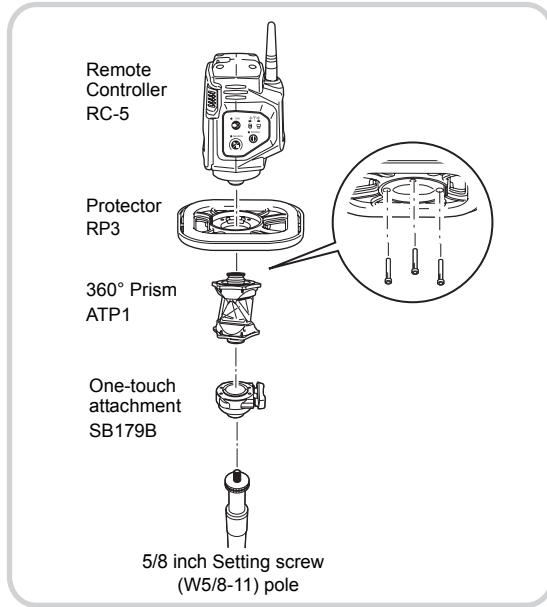
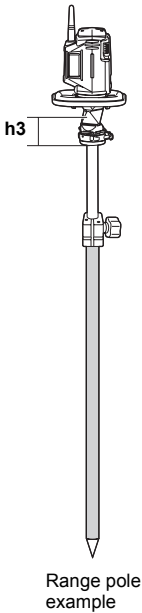

● **Height to center of prism**

The height to the center of the prism differs as shown below depending on the selection of prism/pole combination. Read the following in conjunction with the above diagrams.

Pin Pole Type

- h1: Height from the tip of the prism foot to the center of prism is 10 cm when mounting the 360° Prism ATP1 on the adapter SB184 and stainless steel prism foot AP66.
- h2: Height from the tip of the prism foot to the center of prism is 10 cm when mounting the 360° Sliding Prism ATP1S on the pin pole for ATP1S PP2 and the prism is at the lowest position on the pole. Graduations on the pin pole for ATP1S PP2 are at 5cm intervals. Aligning the top of the sliding prism with one of the graduations then sliding up or down to the next graduation will result in a vertical movement of 5 cm. Maximum range of the sliding pole is 40 cm.



•Do not subject the prism to strong shock when set at the highest position on the pin pole. Otherwise, the prism may slip downwards.

Range Pole Type

- h3: Height from the base of the one-touch attachment to the center of prism is as follows when mounting the 360° Prism ATP1 on the Range Pole.
5/8 inch Setting screw pole with SB179B: 74 mm

● Attaching/Releasing the One-touch attachment

Screw the One-touch attachment all the way into the pole.

Slide the lock release button to the right then press to attach/release the prism.

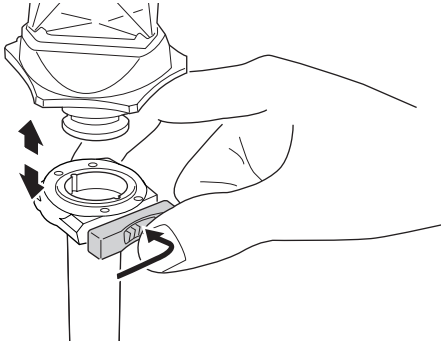

● Adjusting position of 360° Prism (ATP1S) on pin pole (PP2)

Pressing the release button allows the prism to slide up and down the pin pole. Release the release button to secure the prism at the desired position.



- A strong shock, such as dropping the prism, when the prism is mounted on the pin pole or when used as a stand-alone prism may cause the release button to lock. In this event, turn the prism upside down so the the release button is facing downwards and lightly tap the prism or pin pole on a hard surface such as concrete.

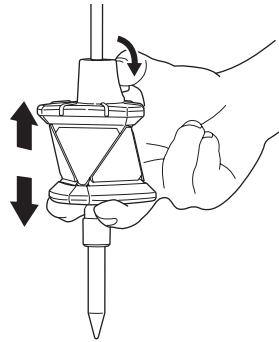

● **Connecting the 360° Prism to the Remote Controller**

Attach the 360° Prism to the Remote Controller so that the center of the Remote Controller and the sighting direction of the prism are aligned and the laser projection port is pointing in the same direction as the prism sighting direction.

Check the stickers to make sure the prism is the right way up.

☞ Prism sighting direction "12.1 High Accuracy with the 360° Prism"

Adjust as follows when the center of the Remote Controller and the sighting direction of the prism are not aligned. Detach the Protector RP3 and loosen adjusting screw (1) with the hexagonal wrench. Re-position the prism, then fix in place. If the Remote Controller and sighting direction are still not aligned, detach the 360° Prism and adjust adjusting screw (2). First move adjusting screw (2) fully to the left or right position and secure in place, then attempt re-alignment again using adjusting screw (1). If the desired result is still not obtained try moving adjusting screw (2) to the opposite position, then attempt re-alignment with adjusting screw (1) again.

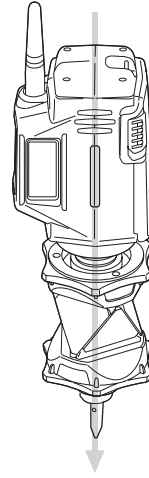

Direction in which 360° Prism is attached

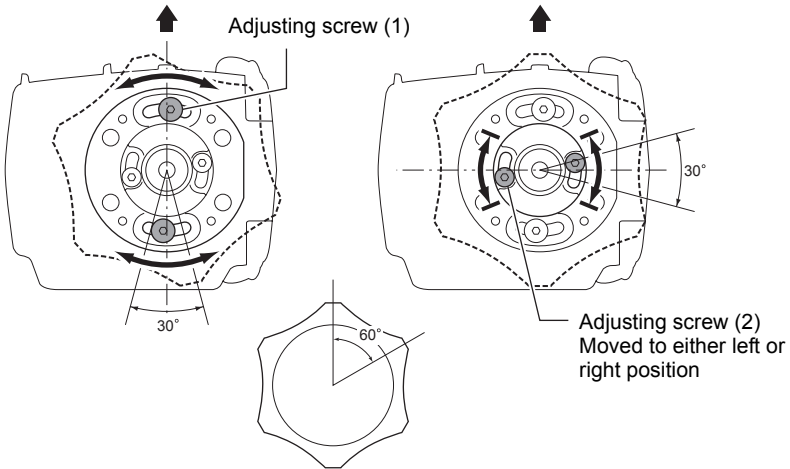

6. SETTINGS FOR THE PS

The following settings are necessary in order to use the PS as part of the Remote Control System.

- ☞ For further functions and operations, see the operator's manual for your total station.
For further details regarding *Bluetooth* communications, see "2. PRECAUTIONS Precautions concerning Bluetooth wireless technology"

6.1 Settings for *Bluetooth* Communication



- *Bluetooth* communication causes PS battery power to be depleted at a rate higher than that for normal operation.

When communicating between the total station and Remote Controller using *Bluetooth* wireless technology, the modem for the total station will be set as the "Master" device and the PS will be set as the "Slave" device.

1. Select "Comms" in SETTINGS mode. Set "Comms mode" in the Comms setup tab to "*Bluetooth*".
Check that the status panel icon has changed to .



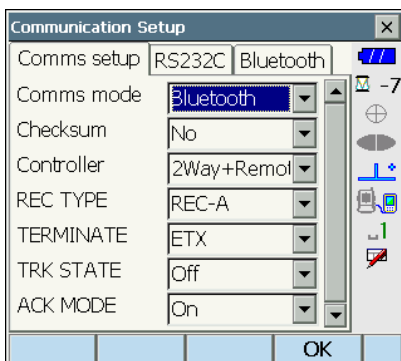
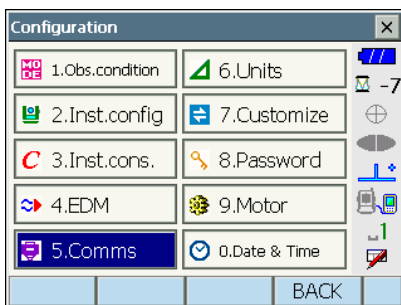

- Changing communication settings during *Bluetooth* communication will cancel the connection.
- The  status bar icon cannot be tapped in <Communication Setup>.





- Select "Slave" as the PS mode and press **[OK]**. Selection can also be made by tapping the  icon in the status panel until a menu appears.

Note

- When communicating between a data collector and the Remote Controller using *Bluetooth* wireless technology, set modem for the data collector as the "Slave" device. Set the data collector as the "Master" device.

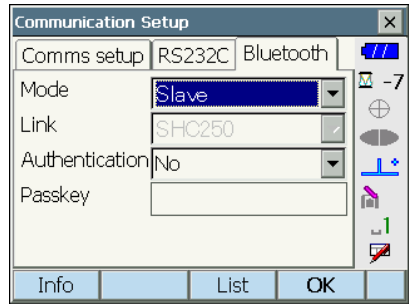
 "7.4 Communication Status"  *Bluetooth* connections"



- The display returns to Meas mode and PS enters "Waiting" mode. The Remote Controller searches for the total station wireless device and initiates a connection.
 -  "7.2 Configuring Bluetooth Connections to the PS"

- When a connection has been successfully established  is displayed in the status bar.

- COM1 on the Remote Controller control panel is lit.

Note

- Press **[Info]** in the *Bluetooth* tab to display the *Bluetooth* device address.

6.2 Settings for Auto Pointing and Auto Tracking







- Auto Pointing model does not support Auto Tracking.

► PROCEDURE

1. Select "Motor" in <Configuration>. Set Auto Pointing/Auto Tracking functions in the Configuration tab.
For Auto Pointing only set "A.T. Setting" to "Search". For Auto Tracking, set "A.T. Setting" to "Track" and "AUTO AIM" to "Fine". Set "Srch method" to "R.C."

Settings and Options

- (1) AUTO AIM 
 - Fine/Rapid
- (2) MEAS Acc. 
 - Advanced/Standard
- (3) Track Setting
 - None/Search/Track
- (4) Srch method 
 - G.S./R.C.
- (5) TURN 
 - 3"/5"/10"/20"/30"/60"

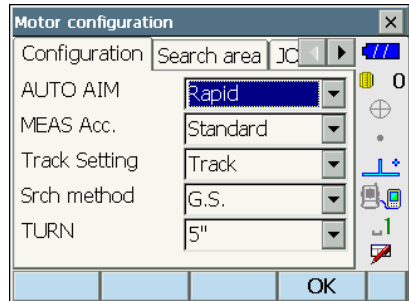
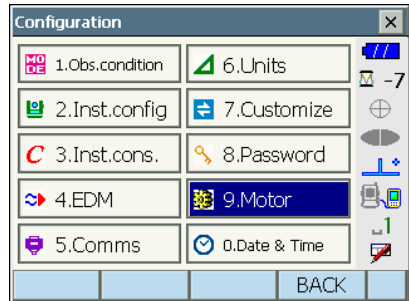

Auto AIM

When the target enters the field-of-view within the set limit for Auto Pointing completion (the limit differs between "Fine" and "Rapid"), the instrument starts acquiring data (the amount of data differs between "Fine" and "Rapid") then completes the Auto Pointing by calculating the data. Set to "Fine" for greater accuracy during Auto Pointing. Make sure that the prism is securely mounted on a tripod etc.

Set to "Rapid" when supporting the pole by hand.

When "Fine" is set the instrument checks that the prism position is stable, then searches for the prism direction. Once the instrument confirms that the prism is sighted at the approximate center of the field-of-view, Auto Pointing is complete. Although this setting provides greater accuracy, when supporting the pole by hand, hand movements will result in Auto Pointing taking too long to complete and a "Time out" error will occur.

When "Rapid" is set however, Auto Pointing can be performed even with slight instability of prism position or minor shifts of target position in the field-of-view. The instrument will use the data obtained to determine the direction of the target.

Auto Pointing performed using the "Rapid" setting can be completed in a much quicker time than the "Fine" setting.

"Fine" is recommended when a high level of measurement accuracy is needed. The range for the offset between the target and reticle after Auto Pointing completed changes as shown below depending on the Srch. accuracy setting.



Measure Acc.

This setting refers to internal operation of the Auto Pointing function.

In the "Advanced" setting, Auto Pointing movement before completion is constant. As a result, Auto Pointing takes longer to complete depending on the target position, but sighting accuracy is improved.

In the "Standard" setting, Auto Pointing movement is not constant, because the most direct way to the target is chosen. That means the "Standard" setting enables Auto Pointing at a comparatively faster speed than "Advanced".

In the "Advanced" setting, the offset between telescope reticle and the target center may larger than that of "Standard".



Srch method

Selects search before distance measurement option.

When set to "G.S." the instrument will search for the target in the area specified in the Search area tab. When set to "R.C.", the instrument will wait for a Turning command to be issued from the RC-Controller before starting Auto Pointing. Such commands can only be received when using instruments have a .



TURN

This option allows the user to set a tolerance range for setting accuracy (after rotation to a specified angle). For example, when this option is set to 30" and [TURN], [H.ANG], or [INV] is pressed, the instrument will stop rotation within 30" of the specified rotation angle.



Search operation during Auto Pointing

When the target enters the field-of-view within the set limit (setting of "Auto AIM") for Auto Pointing completion, the instrument stops moving, calculates the offset between the target and telescope reticle by image processing, then compensates the angle measurement value obtained from the encoder. This compensation enables accurate sighting in a short time. Even though the target and telescope reticle may appear to be misaligned, it does not affect the sighting accuracy. Compensated values are displayed in blue.

If the instrument is rotated (manually or using the Jogs) more than 10", compensation will be canceled, the angle reverts to that obtained from the encoder, and the angle values are once again displayed in black. Compensation is automatically performed when performing Auto Tracking. Terminating Auto Tracking or powering OFF the instrument will cancel the compensation function.

- Set "Srch. method" to "R.C." in order to start Turning operation in response to a Turning command issued from the Remote Controller. Set to "G.S." to search for the target in the area specified in the Search area tab.

- Set the area in which to perform target sighting in the Search area tab.

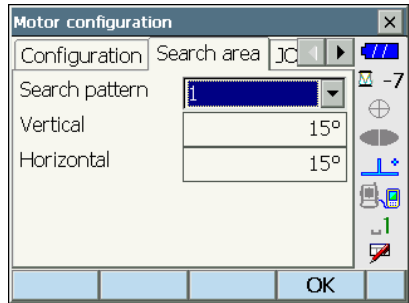

- When necessary, set the Jog turning speed for vertical and horizontal rotation of the telescope. The "Shift" point signifies the dial turning speed at which telescope rotation switches from the Lo speed setting to the Hi speed setting. The higher the "Shift" point setting, the faster the Jog turning speed needed to activate the "Hi" speed setting.

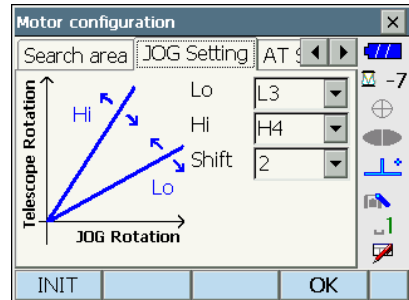

Settings and Options

- Lo
1 to 4 (steps. 4 is fastest)
- Hi
1 to 7 (steps. 7 is fastest)
- Shift point
1 to 6 (steps)

Press **[INIT]** to return JOG Setting tab settings only to their factory settings.

- Set "Forecast time" and "Wait time" / "Target lost".
 "Forecast time", "Wait time", "Target lost":
 Lost Prism

Items set and options

- Forecast time : 0.5 sec./1 sec./2 sec./3 sec./4 sec./5 sec./Auto
- Wait time : 0 to 3600 (sec.)

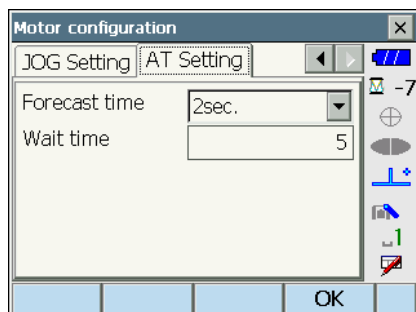

- Press **[OK]**.

6.3 Performing Turning from the PS

It is possible to allocate PS softkeys for both designating the Turning direction, and issuing the instruction to start Turning.

 For allocating softkey functions, see the PS series Operator's Manual

● PS softkey operation

- **[RC]:** PS begins Turning directly in the direction of the Remote Controller.
- **[← RC] :** PS begins Turning in a counterclockwise (left) direction (from the point of view of the operation panel).
- **[RC →]:** PS begins Turning in a clockwise (right) direction (from the point of view of the operation panel).
- **[RC Cont]:** Nullifies the current measurement position and continues Turning operation.

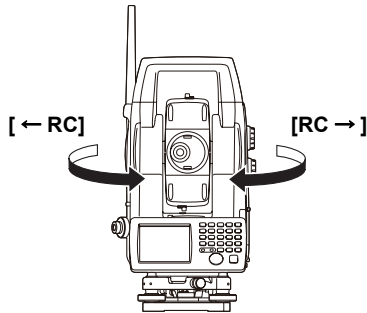

The functions of the following softkeys change according to the settings made in "A. T. Setting" and "Srch method" in <Motor configuration>.

When "Search" is set

"Motor" setting Softkey	When "Search" set in "A.T. Setting"		When "None" set in "A.T. Setting"
	"Srch method" is R.C.	"Srch method" is G.S. (Global Search)	
[SRCH]	Performs Auto Pointing		
[DIST]	Performs Turning operation then angle/distance measurement	Performs Auto Pointing then angle/distance measurement	Performs angle and distance measurement
[RC]	Rotates directly in the direction of the Remote Controller then performs Auto Pointing		
[<-RC]	Rotates in a counterclockwise direction (from the point of view of the Remote Controller) then performs Auto Pointing		
[RC->]	Rotates in a clockwise direction (from the point of view of the Remote Controller) then performs Auto Pointing		
[RC Cont]	Nullifies the current measurement position then continues Turning operation		
[AT On]	Performs Turning operation then Auto Tracking	Performs Auto Pointing then Auto Tracking	Performs Auto Tracking *1

● When "Track" is set

"Motor" setting Softkey	When "Track" set in "A.T. Setting"		When "None" set in "A.T. Setting"
	"Srch method" is R.C.	"Srch method" is G.S. (Global Search)	
[SRCH]	Performs Auto Pointing then Auto Tracking		Performs Auto Pointing
[DIST]	Performs Turning operation then distance measurement/Auto Tracking	Performs Auto Pointing then distance measurement/Auto Tracking	Performs angle and distance measurement
[RC]	Rotates directly in the direction of the Remote Controller then performs Auto Pointing		Rotates in the direction specified by the Remote Controller then performs Auto Pointing
[<-RC]	Rotates in a counterclockwise direction (from the point of view of the Remote Controller) then performs Auto Pointing/Auto Tracking		Rotates in a counterclockwise direction (from the point of view of the Remote Controller) then performs Auto Pointing
[RC->]	Rotates in a clockwise direction (from the point of view of the Remote Controller) then performs Auto Pointing/Auto Tracking		Rotates in a clockwise direction (from the point of view of the Remote Controller) then performs Auto Pointing
[RC Cont]	Nullifies the current measurement position then continues Turning operation/Auto Tracking		Nullifies the current measurement position then continues Turning operation
[AT On]	Performs Turning operation then Auto Tracking	Performs Auto Pointing then Auto Tracking	Performs Auto Tracking *1

*1: Pressing [AT On] when A.T. Setting is set to "None" will result in one of the following operations being performed.

When "R.C." selected: Performs Turning operation then Auto Tracking

When "G.S." selected: Performs Auto Pointing then Auto Tracking

6.4 Turning Error

When Turning fails to detect the prism, an error occurs

When the laser beam from the Remote Controller is reflected off an unrelated object the PS completes Turning operation pointing at the object instead of the Remote Controller. When this happens, press **[RC Cont]** to nullify the current measurement position and continue Turning operation.



Lost Prism

In the event that an obstacle prevents the instrument sighting the target during Auto Tracking, the instrument will predict the direction in which the target will travel and continue Auto Tracking based on this prediction for the time period set in "Forecast time". If the instrument re-acquires the target in this predicted direction, Auto Tracking continues without change. If the target is not re-acquired however, the target is considered "lost" ("Target lost" status) and the instrument starts "horizontal search", "Prism wait" and "re-search" in order. If the instrument re-acquires the target in this process, Auto Tracking continues.

"Prism wait" will continue for the time period set in "Wait time".

If the target is not re-acquired after "re-search", sighting terminates.

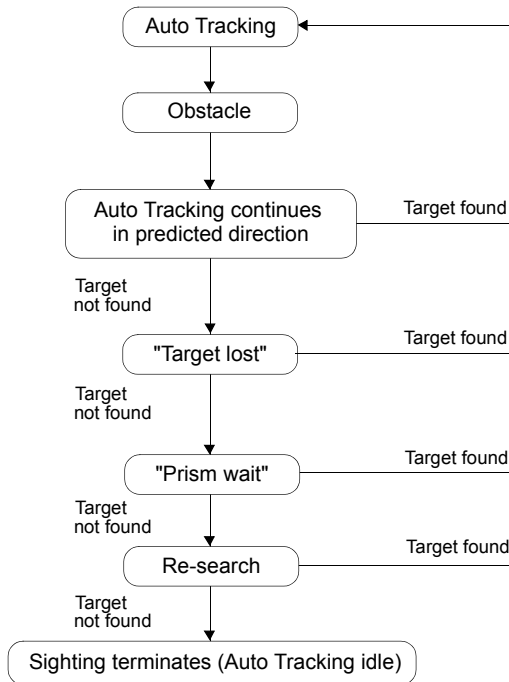

For error messages, see the PS series Operator's Manual

7. BASIC OPERATION

This section explains basic operation of the Remote Controller.

7.1 Using the Battery

Mount the charged battery (BDC46C). When the remaining battery power becomes low, the ● **POWER** Flashes.

☞ Types of power source: "10.1 Power Supply System"



- Remove the battery when the instrument is not being used.
- Before removing the battery, turn off the power to the instrument. If the battery is removed while the power is switched on, a warm boot occurs.
- When installing/removing the battery, make sure that moisture or dust particles do not come in contact with the inside of the instrument.
- Do not use if the terminals are dirty. If dirty, wipe clean with a soft dry cloth.
- To clean other parts of the unit, lightly moisten a soft cloth with water or a mild detergent solution. Wring out excess water until the cloth is slightly damp, then carefully wipe the surface of the unit. Do not use any organic solvents or alkaline cleaning solutions.
- Remove from the surveying instrument or charger before putting the battery into storage.
- Store the battery in a dry room where the temperature is within the following ranges
 - 1 week or less : -20 to 50°C
 - 1 week to 1 month : -20 to 45°C
 - 1 month to 6 months : -20 to 40°C
 - 6 months to 1 year : -20 to 35°C
- For long-term storage, the battery should be charged at least once every six months.
- This battery generates power using a chemical reaction and as a result has a limited lifetime. Even when in storage and not used for long periods, battery capacity deteriorates with the passage of time. This may result in the operating time of the battery shortening despite having been charged correctly. In this event, a new battery is required.

► PROCEDURE Mounting the battery

1. Slide down the catches on the battery cover to open.
2. Insert the battery in the direction of the arrow printed on the side and press down.
3. Close the battery cover. A click is heard when the cover is secure.

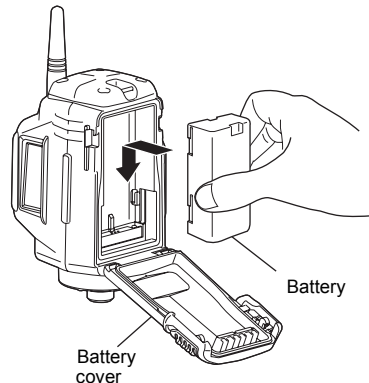



► PROCEDURE Removing the battery

1. Slide down the catches on the battery cover to open.
2. Push the battery up to release.
3. Close the battery cover. A click is heard when the cover is secure. Make sure that both catches on the battery cover have returned to their original positions.

7.2 Configuring *Bluetooth* Connections to the PS



The Remote Controller should be set to "Master" when pairing the total station with the Remote Controller for *Bluetooth* wireless communication for the first time. The Remote Controller searches for the total station wireless device and initiates a connection.

1. Turn on the total station and select "Slave" in communication settings.
 "6.1 Settings for Bluetooth Communication"
2. Turn on the Remote Controller while pressing the SEARCH button . ● **FAR** flashes and the Remote Controller searches for the total station wireless device. When the search is complete an audio tone sounds to indicate the number of devices found. Proceed to step 3.



If the total station wireless device is not found an audio tone sounds continuously and the Remote Controller powers off automatically.



Check communication settings and conditions.

 "2. PRECAUTIONS Precautions concerning Bluetooth wireless technology"

3. ● **COM1** and ● **FAR** are lit when the audio tone stops. When  is displayed on the status bar of the total station companion device, press the FAR button  to confirm the pairing. The Remote Controller automatically powers off.

When  is displayed on the status bar of the total station companion device, the Remote Controller is currently paired to different device.

Press the SEARCH button  to switch the pairing from the current device to the next locally available device. If  is displayed after a brief period, press the FAR button 

to confirm the pairing. If however,  continues to be displayed, press the FAR button  until the status bar icon changes. If the SEARCH button  is pressed as many times as there are locally available devices and the status bar icon still does not change, an audio tone sounds continuously and the Remote Controller automatically powers off.

The wireless device for the total station was not found. Check communication settings and conditions.

 "2. PRECAUTIONS Precautions concerning Bluetooth wireless technology", "6.1 Settings for Bluetooth Communication"

7.3 Button Operations

The Remote Controller is operated using the buttons on the control panel.

7.3.1 Power ON/OFF

Press the POWER button  to switch ON the Remote Controller. ● **POWER** is Lit.

Press and hold the POWER button  to switch OFF the Remote Controller. An audio tone sounds twice and ● **POWER** Flashes before an audio tone sounds and the Remote Controller switches OFF.

7.3.2 Setting Distance Mode

The FAR button  is used to set the Distance Mode depending on the distance between the total station and the Remote Controller.

Pressing the FAR button  switches the ● FAR from Lit to Off and vice versa.

Lit: Far Mode

Off: Standard Mode

Set to Far Mode when the distance between the total station and the Remote Controller is over 100m (normal atmospheric conditions)/150m (good atmospheric conditions).



Atmospheric conditions

- Normal: slight haze, visibility about 20 km, sunny periods, weak scintillation.
- Good: no haze, visibility about 40 km, overcast, no scintillation.





- Set to Standard Mode (● FAR is Off) when the total station and Remote Controller are close.
- Using Far Mode (● FAR is Lit) when the total station and Remote Controller are close could result in the emitted laser beam being reflected off nearby objects. If this happens the total station will complete Turning pointing to the object instead of the Remote Controller.
- Set to Far Mode (● FAR is Lit) even when the distance between the total station and the Remote Controller is 100m or less if the height difference is large.
- Far Mode depletes battery power at a greater rate than Standard Mode.

The FAR button  cannot be pressed while the total station is Turning.

7.3.3 Starting Turning Operation

Press the SEARCH button  to start Turning operation.

- ● SEARCH Flashes when the total station is currently performing Turning operation.
- When Turning operation is complete, an audio tone sounds and ● SEARCH remains Lit for approx. 2 seconds.
- Press the SEARCH button  during operation to stop Turning.
- If the total station fails to detect the prism, a long audio tone sounds and ● SEARCH Flashes quickly for approx. 2 seconds to indicate that an error has occurred.
- When the laser beam from the Remote Controller is reflected off a unrelated object the total station completes Turning operation pointing at this object instead of the Remote Controller. When this happens, press and hold the SEARCH button  to nullify the current measurement position and continue Turning operation.

7.4 Communication Status

The *Bluetooth* wireless modem incorporated in the Remote Controller allows simultaneous communication between the Remote Controller and both the total station and data collector. COM1 is designed for long-range (line-of-sight distance up to 300m) communication with the total station. COM2 is for communication with data collectors. COM2 usable range varies depending on the usable range of the companion device.



Bluetooth connections



Communication between a pair of *Bluetooth* devices requires one device to be set as the "Master" and the other as the "Slave". To initiate connections from the PS side, set the PS as the "Master" device. To initiate connections from the paired device side, set the PS as the "Slave" device. The factory setting for the PS is "Slave".

Bluetooth connections are as follows:

COM1: Total station (Slave) - Remote Controller (Master)

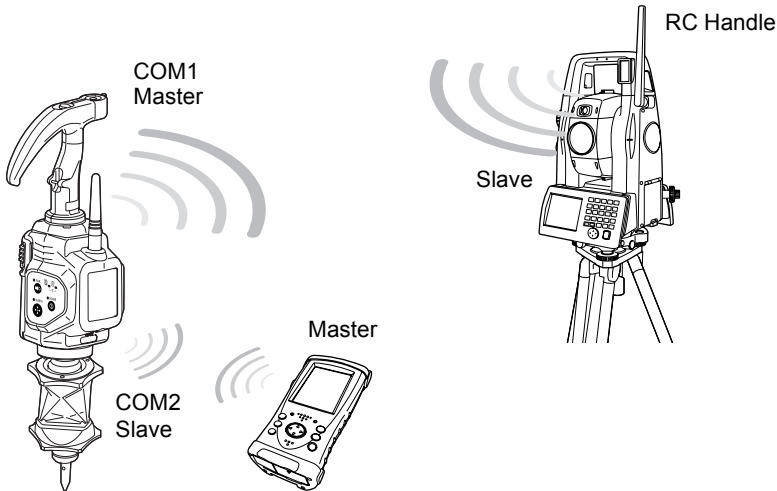
COM2: Data collector (Master) - Remote Controller (Slave)



Port	Control panel status	
	Lit	Flashing
COM1  (total station)	Comm OK	Searching for total station
COM2  (data collector)	Comm OK	Data collector is searching for Remote Controller

7.5 Calibrating the Electronic Compass

The onboard electronic compass was calibrated before being shipped from the factory. A function within the compass will automatically perform any necessary calibration in response to changes in the magnetic field. Although this function by itself is sufficient in normal situations, when the Remote Controller becomes highly magnetized, manual calibration is necessary.





- When the power is ON, automatic calibration is performed to adjust for changes in temperature and magnetic field. When transporting the Remote Controller, with the power still ON, using modes of transport such as cars or trains which contain a large amount of magnetic substance (iron, magnets etc.), this function will calibrate for the magnetic field of said car or train. As a result, the direction in which the Remote Controller instructs a rotation in subsequent surveying tasks may not be correct. Always turn the power OFF when transporting.
- Manually calibrate the compass in the event that the Remote Controller has been transported with the power still ON and the resulting calibration inaccuracy persists.
- The ideal location for performing manual calibration would be an open area clear of any objects. Failing that, make sure that the surrounding area (i.e. several meters around the instrument including ground level) is clear of metallic objects (desks, steel frames, etc.) or devices containing magnets.
- Hold the Remote Controller on the pole at a height of at least 1m.
- Avoid physical contact with metallic objects (cellular phones, tape measures, etc.) or magnetic objects (such as magnetic necklaces) while performing manual calibration.

► PROCEDURE Checking whether manual calibration is necessary

1. Press the POWER button  to switch ON the Remote Controller. ● POWER is Lit.
If ● FAR and ● SEARCH flash and a rapid error tone sounds repeatedly, relocate to a position several meters away from metallic objects (desks, steel frames, etc.) or devices containing magnets before trying again.
If the audio tone continues to sound even after changing location, manual calibration is necessary.
2. When calibration is necessary, switch OFF and proceed to "PROCEDURE Manually calibrating the compass".



► PROCEDURE Manually calibrating the compass

1. Press the POWER button  while pressing the FAR button  with the power switched OFF. An audio tone sounds and the Remote Controller is switched ON in calibration mode.
 - FAR and ● SEARCH are Lit.
2. Hold the Remote Controller vertical and press the SEARCH button .
 - FAR flashes red and calibration starts.
3. Without moving the position of the Remote Controller, rotate it 1.5 to 2 times in a horizontal direction.



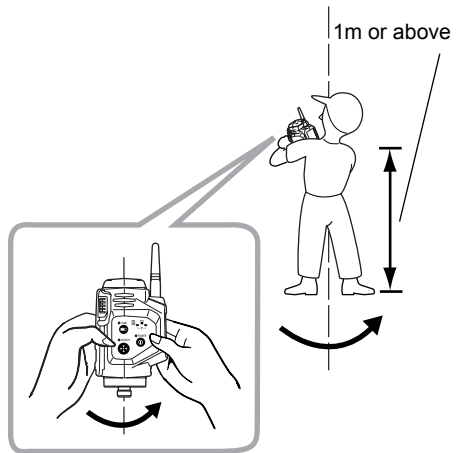

Rotate 1.5 to 2 times in approximately 10 seconds.

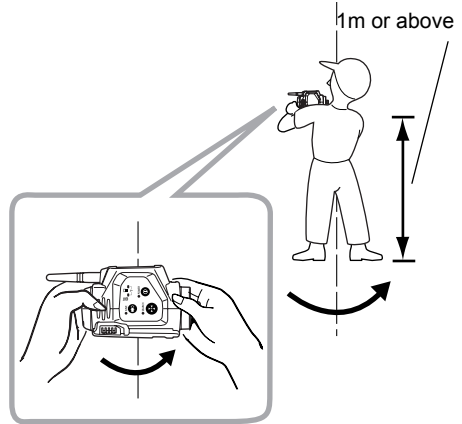

4. After rotating, continue to hold the Remote Controller vertical and press the SEARCH button .
 - SEARCH turns Off.
5. Hold the Remote Controller horizontal and press the SEARCH button .
 - FAR Flashes.

- Without moving the position of the Remote Controller, rotate it 1.5 to 2 times in a horizontal direction.





- After rotating, continue to hold the Remote Controller horizontal and press the SEARCH button .
- **FAR** turns Off.
- Push and hold the POWER button  on the Remote Controller to switch OFF. ● **POWER** turns Off and calibration is complete.



8. ERROR INDICATIONS

When an error occurs, the nature of the error is indicated by the condition of the LEDs on the Remote Controller.



LED Condition	Error
<p>● POWER Flashing</p>	<p>Remaining battery power is low. Replace the batteries. ☞ "7.1 Using the Battery"</p>
<p>3 long audio tones and the ● POWER Flashes then power is cut off</p>	<p>No battery power remaining. Replace the batteries. ☞ "7.1 Using the Battery"</p>
<p>● POWER Flashes quickly and audio tone continues to sound/audio tone sounds for approx. 10 seconds</p>	<p>The remaining battery power of the total station is low or the total station has switched OFF. Check the power to the total station. ☞ Operator's manual for your total station</p>
<p>● FAR/all LEDs Flashing quickly</p>	<p>Hardware error. Switch the power to the Remote Controller OFF and ON again. If the error reoccurs after restart, contact your local dealer.</p>
<p>A long audio tone sounds and ● SEARCH Flashes quickly for approx. 2 seconds</p>	<p>Turning failure ☞ "9. TROUBLESHOOTING"</p>
<p>3 audio tones and the ● FAR/ ● SEARCH Flash</p>	<p>There are magnetic/metallic objects in the vicinity. Retry at a distance greater than several meters from such objects. If the audio tone continues to sound even after changing location, manual calibration is necessary. ☞ "7.5 Calibrating the Electronic Compass"</p>

9. TROUBLESHOOTING

- Pressing the POWER button  does not switch ON the power.
 - Check that the battery has been inserted.
Replace the battery.
 "7.1 Using the Battery"

- The total station does not perform Turning operation even when distance measurement is executed.
 - The Turning operation setting of the total station is deactivated.
Set the "Srch method" setting for the PS to "R.C.".
 "6.2 Settings for Auto Pointing and Auto Tracking"
 - A connection has not been established with the total station.
Check the pairing settings and communication conditions for the total station and Remote Controllers being used.
 "6.1 Settings for Bluetooth Communication", "7.2 Configuring Bluetooth Connections to the PS"

- Turning operation failure
 - Both the laser projection port and the prism are not pointing in the direction of the total station.
Point the laser projection port and the prism towards the total station.
 - The total station cannot receive the beam emitted from the Remote Controller as the amount of light is too low.
Check that the Distance Mode setting is correct.
 "7.3.2 Setting Distance Mode"
 - Turning operation has located the horizontal position but cannot find the vertical position.
Turning operation for the vertical position cannot be performed while the pole is tilted at an angle.
Check that the pole is fixed in the correct position, vertically over the measurement point.
 - Check that there are no obstacles between the beam detector of the total station and the laser projection port of the Remote Controller/prism.
 - Flat white surfaces in close proximity to the optical path between the total station beam detector and Remote Controller laser projection port may reflect the emitted laser beam and cause Turning operation failure. Have someone stand in front of such objects or otherwise cover, such as with a dark-colored cloth.
 - There is dust or dirt on the beam detector/laser projection port.
Dust off minute particles with the lens brush before carefully wiping with the cleaning cloth.

- Total station finishes Turning operation pointing in the wrong direction.
 - The total station receives the emitted laser beam after it has been reflected off a highly-reflective surface in the vicinity of the Remote Controller.
Continue Turning operation.
 "4.2 Measurement Flow"
 "6.3 Performing Turning from the PS"

- The signal for the data collector/Remote Controller equipped with Bluetooth wireless technology is weak.
 - The wireless modem signal is poor because the data collector/Remote Controller is placed in a low position, close to ground level.
Place the modem in as high a position as possible.

10. OPTIONAL ACCESSORIES



- Place the instrument in its case in accordance with the layout plan on the inside of the carrying case.
- Place the data collector in its dedicated protective case before inserting into the carrying case.

For use with other prism types, contact your local dealer.

360° Prism (ATP1)

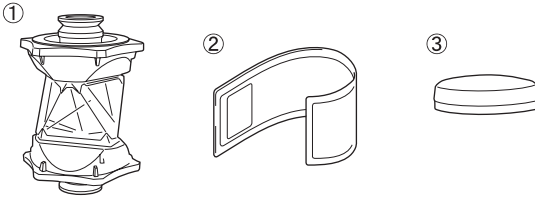

1	360° Prism (ATP1)	1
2	Protective cover	1
3	Cap	1

● Protective cover

Attach the protective cover when the prism is not being used to protect the prism surface from dirt and damage.

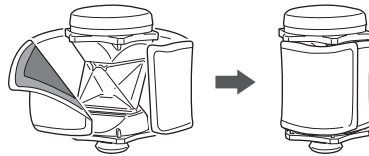

Note

- The inner (light grey) section can be used as a cleaning cloth to wipe the surface of the prism.

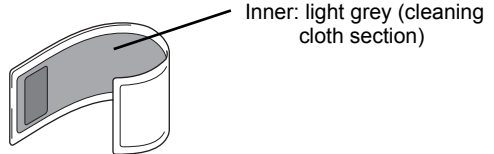

360° Sliding Prism (ATP1S)

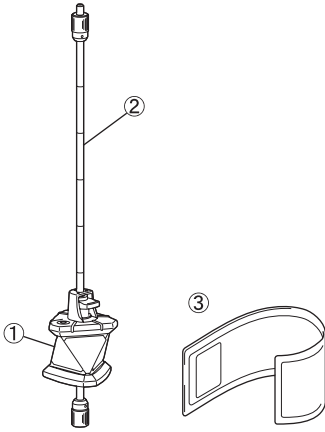

- 1 360° Sliding Prism (ATP1S)..... 1
- 2 Pin Pole for ATP1S (PP2) 1
- 3 Protective cover..... 1

The 360° Sliding Prism can be packed away in the carrying case (SC228). Packing is secured inside the carrying case to protect the contents. Remove this packing and place the prism at the bottom of the case.



- Be careful when removing the packing. Otherwise, the fastening may break.

RC-Handle (RC-5RH)

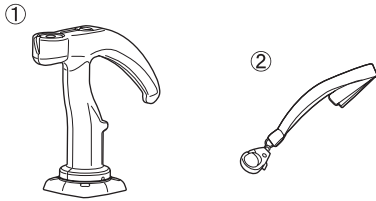

- 1 RC-Handle (RC-5RH)..... 1
- 2 Strap 1

Protector (RP3)

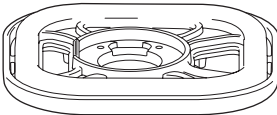

10.1 Power Supply System

Operate your RC-5 with the following combinations of power equipment.



- Never use any combination other than those indicated below. If you do, the instrument could be damaged.

Those indicated by * are standard accessories. Others are optional accessories (sold separately)

● Battery

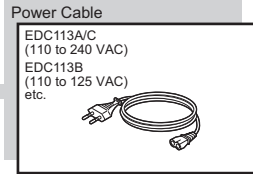
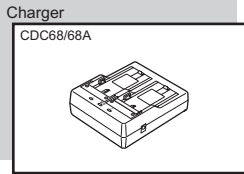
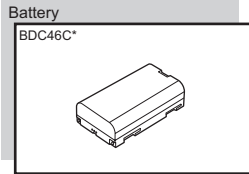

The power cable shown here is EDC113A



- Dedicated power cables differ according to the country or the area where the instrument is used. Contact your local dealer for the details.

11. SPECIFICATIONS

Whole System Specifications

Range:	(Slope distance between instrument and measuring point) (normal atmospheric conditions ^{*1})
Standard Mode:	2 ^{*2} to 100m ^{*3}
Far Mode:	2 ^{*2} to 250m ^{*4} /300m ^{*3}
Operating time ^{*5} :	About 15 sec. ^{*1} /18 sec. ^{*6} Up to finishing distance measurement (Rapid (single))
Operating range of function for automatically determining rotation direction:	Magnetic inclination is 80° or less and horizontal component is more than 10 μ T ^{*7}
Data collector:	TOPCON total station-compatible product ^{*7}
Control panel (keyboard)	3 Keys
Indicator	5 LED
Audio tone	Yes
Operating temperature	-20 to 50°C
Storage temperature range	-30 to 70°C
Water resistance	IP55 (IEC 60529:2001)
Size	69 (L) X 80.5 (W) X 131 (H) mm (excluding antenna)
Weight	About 420 g (with BDC46C)

- *1: Normal: Slight haze, visibility about 20 km, sunny periods, weak scintillation.
- *2: Possible to use 1.8m (horizontal distance), height of instrument point and measurement point is almost the same, instrument height is 1.5m, and prism height is 0.10m.
- *3: About 20m height difference between instrument and Remote Controller laser projection port.
- *4: About 40m height difference between instrument and Remote Controller laser projection port.
- *5: Time taken between the start of the search and the obtaining of distance measurement results after the completion of Auto Pointing. Normal atmospheric conditions, instrument Turning horizontally 90°, 100m distance between instrument and measuring point.
Depends on the conditions and wireless modem used.
- *6: At a distance of less than 5m, pole leaning slightly.
- *7: For details, contact your local dealer.

Remote Controller (RC-5)

Laser Projection Port

Signal source	Laser diode (IEC60825-1 Ed. 2.0: 2007/FDA CDRH 21 CFR Part 1040.10 and 1040.11 (Complies with FDA performance standards for laser products except for deviations pursuant to Laser Notice No.50, dated June 24, 2007.))
Wavelength:	785nm
Beam projection area	
Horizontal direction:	-10 to 10°
Angle of elevation:	More than 30°
Angle of depression:	More than 30°

Rotation direction detector

Direction detector	magnetic compass sensor (geomagnetic measurement method) With automatic/manual calibration function
--------------------	--

Wireless communication

Transmission method:	FHSS
Modulation:	GFSK, $\pi/4$ DQPSK, 8DPSK
Frequency band:	2.402 to 2.480GHz
<i>Bluetooth</i> profile	SPP, DUN
Power class	Class 1
Usable range	300m (No obstacles, few vehicles or sources of radio emissions/ interference in the vicinity of the instrument, no rain) 600m (Paired with PS, with instrument height to be more than 1.5m, no obstacles (like building structures, trees or vehicles) causing interrupting/reflecting radio wave, few sources of radio emissions/ interference in the near vicinity of the instrument, no rain) Usable range of the data collector varies depending on the usable range of the companion device.
Authentication	Yes/No (selectable)
Antenna	External antenna

Power Supply**Battery**

Type:	Rechargeable Li-ion battery BDC46C
Working duration* ⁸ (25°C)	
Standard Mode:	40 hours
Far Mode:	35 hours

Battery (BDC46C)

Nominal voltage	7.2V
Capacity	2.62Ah
Dimensions	38 (W) x 70 (D) x 20 (H) mm
Weight	about 103g

Charger (CDC68/68A)

Input voltage:	AC100 to 240V
Charging time per battery (at 25°C):	BDC46C: about 2.5 hours (Charging can take longer than the times stated above when temperatures are either especially high or low.)
Charging temperature range:	0 to 40°C
Storage temperature range:	-20 to 65°C
Size:	94 (W) X 102 (D) X 36 (H) mm
Weight:	about 170g

*⁸: Repeat Turning with the instrument turned 90° and distance measurement performed in Rapid measurement (single) every 1 minute.

RC-Handle (RC-5RH)

Sensitivity of levels	35'/2mm
Size (when attached to RC-5)	80.5 (W) X 126.5 (D) X 242 (H) mm
Weight (when attached to RC-5, with BDC46C)	About 510g

360° Prism (ATP1)

Measuring range	(Using PS, angles of elevation and inclination both less than 15°)
EDM	1.3 to 1000m ^{*9}
Auto Tracking/Auto Pointing	2 to 600m ^{*9}
Prism constant	7mm
3D positioning accuracy (standard deviation)	3mm (Angles of elevation and inclination both less than 20°)
Prism height	37mm (from mounting face (flange face) when attached to RC-5)
Operating temperature	-20 to 50°C
Storage temperature range	-30 to 70°C
Size	70 (W) X 104 (H) mm (with cap)
Weight	265g (with cap)
*9:	No haze, visibility over 20 km, slightly overcast (less than 30000 lx), no scintillation.

360° Sliding Prism (ATP1S)

Measuring range	(Using PS, angles of elevation and inclination both less than 15°)
EDM	1.3 to 1000m ^{*1}
Auto Tracking/Auto Pointing	2 to 600m ^{*9}
Prism constant	7mm
3D positioning accuracy (standard deviation)	3mm (Angles of elevation and inclination both less than 20°)
Prism height	50mm (When attached to Pin Pole for ATP1S PP2, from bottom of pin pole) 100mm (When attached to Pin Pole for ATP1S PP2 and prism foot AP66, from tip of prism foot)
Prism slide range	50mm to 350mm (When attached to Pin Pole for ATP1S PP2, graduations at 50mm intervals)
Operating temperature	-20 to 50°C
Storage temperature range	-25 to 70°C
Size	
360° Sliding Prism ATP1S	65 (W) X 77.5 (H) mm
Pin Pole for ATP1S PP2	Ø6mm X 432mm (including connecting screw section and pole ends)
Weight	
360° Sliding Prism ATP1S	160g
Pin Pole for ATP1S PP2	110g
ATP1S, PP2 and AP66	290g

12. EXPLANATION

12.1 High Accuracy with the 360° Prism

Sighting can be more accurately performed by facing the 360° Prism toward the total station.



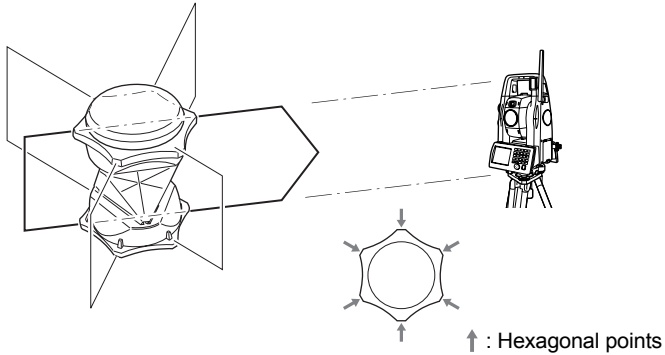

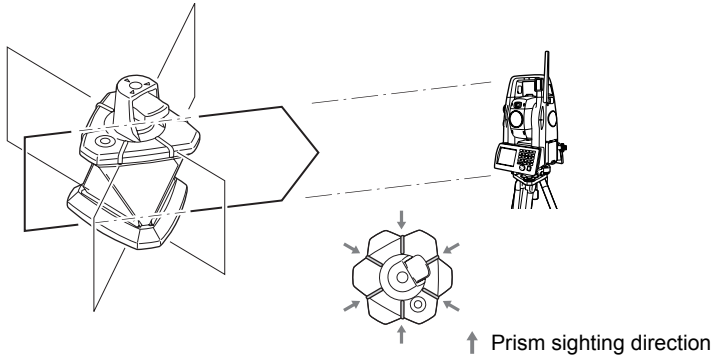

When using the ATP1, the 360° Prism should be set up so that a pair of diametrically-opposed hexagonal points on its rubber flanges are aligned with the sighting direction of the total station (see the diagram below).



When using the ATP1S, the 360° Prism should be set up so that a pair of diametrically-opposed marks on top of the prism are aligned with the sighting direction of the total station.





13. BUTTON OPERATIONS LIST

Operation	Button Operation	Indication
POWER ON	Press  once	● POWER is Lit
POWER OFF	Press and hold 	● POWER Flashes then turns Off
Far Mode	When ● FAR is Off, press  once	● FAR is Lit
Standard Mode	When ● FAR is Lit, press  once	● FAR is Off
Start Turning	Press  once	
Turning in operation		● SEARCH Flashes
Turning complete		● SEARCH is Lit for 2 seconds
Cancel Turning	Press  once while Turning in operation	● SEARCH is Off
Continue Turning	Press and hold 	● SEARCH Flashes

14. REGULATIONS

Region/ Country	Directives/ Regulations	Labels/Declarations
U.S.A.	FCC-Class A	<p>FCC Compliance</p> <p>WARNING: Changes or modifications to this unit not expressly approved by the party responsible for compliance could void the user's authority to operate the equipment.</p> <p>NOTE: This equipment has been tested and found to comply with the limits for a Class A digital device pursuant to Part 15 of the FCC Rules. These limits are designed to provide reasonable protection against harmful interference when the equipment is operated in a commercial environment. This equipment generates, uses, and can radiate radio frequency energy and, if not installed and used in accordance with the operator's manual, may cause harmful interference to radio communications. Operation of this equipment in a residential area is likely to cause harmful interference in which case the user will be required to correct the interference at his own expense.</p> <p>This transmitter must not be co-located or operated in conjunction with any other antenna or transmitter.</p> <p>This equipment complies with FCC radiation exposure limits set forth for uncontrolled equipment and meets the FCC radio frequency (RF) Exposure Guidelines in Supplement C to OET65. This equipment has very low levels of RF energy that is deemed to comply without maximum permissive exposure evaluation (MPE). But it is desirable that it should be installed and operated with at least 20cm and more between the radiator and person's body (excluding extremities: hands, wrists, feet and ankles).</p> <p>Declaration of Conformity Model Number: RC-5 Trade Name: TOPCON CORPORATION</p> <p>Manufacture Name: TOPCON CORPORATION Address: 75-1, Hasunuma-cho, Itabashi-ku, Tokyo, 174-8580 JAPAN 243-0036 Country: JAPAN</p> <p>U.S.A. Representative Responsible party: TOPCON POSITIONING SYSTEMS,INC. Address: 7400 National Drive Livermore, CA94551, U.S.A Telephone number: 925-245-8300</p> <p>Means of conformity This device complies with part 15 of the FCC Rules, Operation is subject to the following two conditions: (1) This device may not cause harmful interference, and (2) this device must accept any interference received, including interference that may cause undesired operation.</p>

Region/ Country	Directives/ Regulations	Labels/Declarations
California and NY, U.S.A.	Recycling Batteries	<p style="text-align: center;"><u>DON'T THROW AWAY RECHARGEABLE BATTERIES, RECYCLE THEM.</u></p> <p style="text-align: center;"><u>Topcon Positioning Systems Inc., United States Return Process for Used Rechargeable Nickel Metal Hydride, Nickel Cadmium, Small Sealed Lead Acid, and Lithium Ion, Batteries</u></p> <p>In the United States Topcon Positioning Systems Inc., has established a process by which Topcon customers may return used rechargeable Nickel Metal Hydride(Ni-MH), Nickel Cadmium(Ni-Cd), Small Sealed Lead Acid(Pb), and Lithium Ion(Li-ion) batteries to Topcon for proper recycling and disposal. Only Topcon batteries will be accepted in this process.</p> <p>Proper shipping requires that batteries or battery packs must be intact and show no signs of leaking. The metal terminals on the individual batteries must be covered with tape to prevent short circuiting and heat buildup or batteries can be placed in individual plastic bag. Battery packs should not be dissembled prior to return.</p> <p>Topcon customers are responsible for complying with all federal, state, and local regulations pertaining to packing, labeling, and shipping of batteries. Packages must include a completed return address, be prepaid by the shipper, and travel by surface mode. <u>Under no circumstance should used/recyclable batteries be shipped by air.</u></p> <p>Failure to comply with the above requirements will result in the rejection of the package at the shipper's expense.</p> <p>Please remit packages to: Topcon Positioning Systems, Inc. C/O Battery Return Dept, 150 7400 National Dr, Livermore, CA 94551</p> <p style="text-align: center;"><u>DON'T THROW AWAY RECHARGEABLE BATTERIES, RECYCLE THEM.</u></p>
Canada	ICES-Class A	<p>This Class A digital apparatus meets all requirements of Canadian Interference-Causing Equipment Regulations. Cet appareil numérique de la Class A respecte toutes les exigences du Règlement sur le matériel brouilleur du Canada.</p> <p>This class A digital apparatus complies with Canadian ICES-003. Cet appareil numérique de la classe A est conforme a la norme NMB-003 du Canada.</p> <p>Operation is subject to the following two conditions: (1) this device may not cause interference, and (2) this device must accept any interference, including interference that may cause undesired operation of this device.</p> <p>This equipment complies with IC radiation exposure limits set forth for uncontrolled equipment and meets RSS-102 of the IC radio frequency (RF) Exposure rules. This equipment should be installed and operated with at least 20cm and more between the radiator and person's body (excluding extremities: hands, wrists, feet and ankles).</p>
Europe	EMC-Class B &TTE-Class 2	<div style="border: 1px solid black; padding: 10px;">  <p style="margin-left: 10px;">EMC NOTICE In industrial locations or in proximity to industrial power installations, this instrument might be affected by electromagnetic noise. Under such conditions, please test the instrument performance before use.</p> </div>

Region/ Country	Directives/ Regulations	Labels/Declarations
Europe	R&TTE-Class 2	<p>R&TTE Directive</p> <p>RC-5 Hereby, TOPCON CORP., declares that the above-mentioned equipment is in compliance with the essential requirements and other relevant provisions of Directive 1999/5/EC.</p> <p>Please inquire below if you wish to receive a copy of Topcon's Declaration of Conformity.</p> <p>Topcon Europe Positioning B.V. Essebaan 11, 2908 LJ Capelle a/d IJssel, The Netherlands Tel: +31-10-4585077 Fax: +31-10-2844949 http://www.topcon-positioning.eu/index.asp</p>
EU	WEEE Directive	<div style="border: 1px solid black; padding: 10px;">  <p>WEEE Directive</p> <p>This symbol is applicable to EU member states only.</p> <p>Following information is only for EU-member states: The use of the symbol indicates that this product may not be treated as household waste. By ensuring this product is disposed of correctly, you will help prevent potential negative consequences for the environment and human health, which could otherwise be caused by inappropriate waste handling of this product. For more detailed information about the take-back and recycling of this product, please contact your supplier where you purchased the product or consult.</p> <p style="text-align: right;">TOPCON CORPORATION</p> </div>
EU	EU Battery Directive	<div style="border: 1px solid black; padding: 10px;">  <p>EU Battery Directive</p> <p>This symbol is applicable to EU member states only.</p> <p>Battery users must not dispose of batteries as unsorted general waste, but treat properly.</p> </div>

TOPCON CORPORATION

75-1 Hasunuma-cho, Itabashi-ku, Tokyo 174-8580, Japan <http://www.topcon.co.jp>

Please see the attached address list or the following website for contact addresses.

GLOBAL GATEWAY <http://global.topcon.com/>
