



Net-G5

GNSS Receiver

Operator's Manual



Net-G5 Operator's Manual

Part Number 1004636-01

Rev F

©Copyright Topcon Positioning Systems, Inc.

January, 2017

All contents in this manual are copyrighted by Topcon Positioning Systems, Inc. All rights reserved.

Table of Contents

.....

Table of Contents	i
Preface	iv
Terms and Conditions	iv
Use	iv
Copyrights	iv
Trademarks	iv
Disclaimer of Warranty	iv
License Agreement	v
Confidentiality	v
Website; Other Statements	v
Safety	v
Miscellaneous	v
Specifications	v
Manual Conventions	vi
Introduction	1
Receiver Features	2
Unpacking Your Receiver Kit	2
Technical Documents	2
Using Topcon Software With Your Receiver	2
Getting Technical Support	3
Website	3
Getting Acquainted	4
Receiver Housing Overview	4
Front Panel View	4
Back Panel View	5
Cables and Power Supply	6
SD Card (Memory)	7
Installing the SD Card	7
Formatting the SD Card	7
Internal Batteries	8
Display Panel	9
Power Button	9
Function Button	10
Receiver Status LEDs	10
Tracking Status LED	10
Recording LED	11
Communication LEDs	11
Bluetooth Only Status	11

Wi-Fi LED	11
Cellular Status	12
Battery LED	12
Power LED	12
Managing Power	13
Turning On/Off the Receiver	13
Using External Power Sources	13
Powering the Receiver	13
Checking Power Status	14
Internal Batteries	14
Charging the Backup Batteries	15
Insufficient Power	15
Configuring the Receiver	16
Configuring the Receiver	16
Using the Web Interface	16
Accessing the Receiver Through the Web Browser	16
Net-G5 Web Interface Ports	18
Viewing Receiver Information	18
Updating Firmware	19
Update Firmware Using TRU.	19
Connect to the Receiver	19
Load the Firmware	21
Verify Firmware Upload	23
Update Firmware Using an SD Card	24
Install Firmware Installation File	24
Begin Firmware Update	24
About the OAF	24
Checking the Receiver's OAF	25
Loading an OAF	26
Resetting the Receiver (Clearing the NVRAM)	30
System Setup	31
Step 1: Setting Up the Receiver	31
Step 2: Measure Antenna Height	32
Step 3: Collecting Data	33
Step 4: Stop Data Logging	33
Static Surveying for Reference Stations	33
Analyzing Signal-to-Noise Ratio	34
Collecting Almanacs and Ephemerides	34
Collecting Data	35
Setting Recording Parameters	35
Using the Vanguard Web Interface	35
Logging Rates	35
Recording Data	35

Managing Files	36
Downloading and Deleting Files	36
Troubleshooting.	37
Check This First!	37
Powering Problems	37
Receiver Problems	38
Bluetooth Problems	40
Cellular Problems	40
TRU Problems	41
Cleaning and Storing the Receiver	41
Getting Customer Support	41
Specifications.	42
General Details	42
Safety Warnings	45
General Warnings	45
Receiver Warnings	45
Usage Warnings	45
Regulatory	46
FCC Compliance	46
Industry Canada Compliance	46
Community of Europe Compliance	46
European Community Declaration of Conformity with R&TTE Directive 1999/5/EC	47
Declaration of Conformity (R&TTE Directive 1999/5/EC)	47
WEEE Directive	49
Bluetooth Transmission Statements/Compliance	49
Korean KC-RF Compliance	49
Korean KC-Cellular Modem Compliance	50
Japan Radio Law and Telecommunications Business Law Compliance	50
Bluetooth and Wi-Fi Module Compliance	50
Cellular Module Compliance	50
Glossary	51

Preface

Thank you for purchasing this Topcon product. The materials available in this Manual (the "Manual") have been prepared by Topcon Positioning Systems, Inc. ("TPS") for owners of Topcon products, and are designed to assist owners with the use of the receiver and its use is subject to these terms and conditions (the "Terms and Conditions").



Please read the terms and conditions carefully.

Terms and Conditions

Use

This product is designed to be used by a professional. The user should have a good knowledge of the safe use of the product and implement the types of safety procedures recommended by the local government protection agency for both private use and commercial job sites.

Copyrights

All information contained in this Manual is the intellectual property of, and copyrighted material of TPS. All rights are reserved. Do not use, access, copy, store, display, create derivative works of, sell, modify, publish, distribute, or allow any third party access to, any graphics, content, information or data in this Manual without TPS' express written consent and may only use such information for the care and operation of the receiver. The information and data in this Manual are a valuable asset of TPS and are developed by the expenditure of considerable work, time and money, and are the result of original selection, coordination and arrangement by TPS.

Trademarks

Net-G5™, TRU™, Magnet™, Pocket-3D™, Topcon® and Topcon Positioning Systems™ are trademarks or registered trademarks of TPS. Windows® is a registered trademark of Microsoft Corporation. The Bluetooth® word mark and logos are owned by Bluetooth SIG, Inc. and any use of such marks by Topcon Positioning Systems, Inc. is used under license. Other product and company names mentioned herein may be trademarks of their respective owners.

Disclaimer of Warranty

EXCEPT FOR ANY WARRANTIES IN AN APPENDIX OR A WARRANTY CARD ACCOMPANYING THE PRODUCT, THIS MANUAL AND THE RECEIVER ARE PROVIDED "AS-IS." THERE ARE NO OTHER WARRANTIES. TPS DISCLAIMS ANY IMPLIED WARRANTY OF MERCHANTABILITY OR FITNESS FOR ANY PARTICULAR USE OR PURPOSE. TPS AND ITS DISTRIBUTORS SHALL NOT BE LIABLE FOR TECHNICAL OR EDITORIAL ERRORS OR OMISSIONS CONTAINED HEREIN; NOR FOR INCIDENTAL OR CONSEQUENTIAL DAMAGES RESULTING FROM THE FURNISHING, PERFORMANCE OR USE OF THIS MATERIAL OR THE RECEIVER. SUCH DISCLAIMED DAMAGES INCLUDE BUT ARE NOT LIMITED TO LOSS OF TIME, LOSS OR DESTRUCTION OF DATA, LOSS OF PROFIT, SAVINGS OR REVENUE, OR LOSS OF THE PRODUCT'S USE. IN ADDITION TPS IS NOT RESPONSIBLE OR LIABLE FOR DAMAGES OR COSTS INCURRED IN CONNECTION WITH OBTAINING SUBSTITUTE PRODUCTS OR SOFTWARE, CLAIMS BY OTHERS, INCONVENIENCE, OR ANY OTHER COSTS. IN ANY EVENT, TPS SHALL HAVE NO LIABILITY FOR DAMAGES OR OTHERWISE TO YOU OR ANY OTHER PERSON OR ENTITY IN EXCESS OF THE PURCHASE PRICE FOR THE RECEIVER.

License Agreement

Use of any computer programs or software supplied by TPS or downloaded from a TPS website (the "Software") in connection with the receiver constitutes acceptance of these Terms and Conditions in this Manual and an agreement to abide by these Terms and Conditions. The user is granted a personal, non-exclusive, non-transferable license to use such Software under the terms stated herein and in any case only with a single receiver or single computer. You may not assign or transfer the Software or this license without the express written consent of TPS. This license is effective until terminated. You may terminate the license at any time by destroying the Software and Manual. TPS may terminate the license if you fail to comply with any of the Terms or Conditions. You agree to destroy the Software and manual upon termination of the use of the receiver. All ownership, copyright and other intellectual property rights in and to the Software belong to TPS. If these license terms are not acceptable, return any unused software and manual.

Confidentiality

This Manual, its contents and the Software (collectively, the "Confidential Information") are the confidential and proprietary information of TPS. You agree to treat TPS' Confidential Information with a degree of care no less stringent than the degree of care you would use in safeguarding your own most valuable trade secrets. Nothing in this paragraph shall restrict you from disclosing Confidential Information to your employees as may be necessary or appropriate to operate or care for the receiver. Such employees must also keep the Confidentiality Information confidential. In the event you become legally compelled to disclose any of the Confidential Information, you shall give TPS immediate notice so that it may seek a protective order or other appropriate remedy.

Website; Other Statements

No statement contained at the TPS website (or any other website) or in any other advertisements or TPS literature or made by an employee or independent contractor of TPS modifies these Terms and Conditions (including the Software license, warranty and limitation of liability).

Safety

Improper use of the receiver can lead to injury to persons or property and/or malfunction of the product. The receiver should only be repaired by authorized TPS warranty service centers. Users should review and heed the safety warnings in an Appendix.

Miscellaneous

The above Terms and Conditions may be amended, modified, superseded, or canceled, at any time by TPS. The above Terms and Conditions will be governed by, and construed in accordance with, the laws of the State of California, without reference to conflict of laws.

Specifications

The graphics in this manual do not depict the actual size of the components.

All specifications are subject to change without prior notice.

Manual Conventions

This manual uses the following conventions:

Convention	Description	Example
Bold	Menu, or drop-down menu selection	File ▶ Exit (Click the File menu and click Exit)
	Name of a dialog box or screen	From the Connection screen...
	Button or key commands	Click Finish .
Mono	User supplied text or variable	Type <code>guest</code> , and click Enter .
<i>Italic</i>	Reference to another manual or help document	Refer to the <i>Topcon Reference Manual</i> .



Further information to note about system configuration, maintenance, or setup.



Supplementary information that can have an adverse affect on system operation, system performance, data integrity, measurements, or personal safety.



Notification that an action has the potential to result in system damage, loss of data, loss of warranty, or personal injury.

Introduction

The Net-G5 is a multi-frequency, GNSS receiver built to be the most advanced and convenient network reference receiver. The integrated receiver design includes a GNSS receiver board based on Vanguard™ technology, internal long-life batteries, memory storage, and optional cellular wireless communication technology. The Net-G5 delivers world-class positioning and navigation capability to your application by tracking signals from multi-constellation satellite systems, including GPS, GLONASS, SBAS, BeiDou, and Galileo.

The Net-G5 can receive and process multiple signal types (including the latest GPS L2C, L5, GLONASS C/A L2, and GALILEO¹ signals) improving the accuracy and reliability of the solution, especially under difficult job-site conditions.



Figure 1: Net-G5 Receiver - Front



Figure 2: Net-G5 Receiver - Back

1. Contact Topcon Technical Support for detailed information about the supported GALILEO signals.

Receiver Features

The following features combine to provide a positioning system efficient, secure, and appropriate for any survey or application that requires highly-accurate timing and positioning solutions:

- 448 universal tracking channels
- Multipath reduction
- Adjustable phase locked loop (PLL) and delay lock loop (DLL) parameters
- 1PPS and event marker
- External oscillator input
- GNSS-disciplined internal crystal oscillator output
- RS232C and USB port connectivity
- USB storage device
- Removable memory
- Backup battery system
- Ethernet connectivity
- Web-based management
- Satellite Based Augmentation Systems (WAAS, EGNOS, etc.)
- Dual- or multi-frequency modes, including static, kinematic, real-time kinematic (RTK), and differential (DGPS) survey modes.
- Ntrip server/client
- Multiple survey parameters, including multiple mask angles, static and dynamic modes, auto data logging, etc.

Unpacking Your Receiver Kit

This section describes the documentation, standard kit components, and accessories (depending on your purchase) that accompany your receiver. When you unpack your receiver kit, verify you received the items listed in this section. Make sure the items do not appear damaged from shipment. If any of the items are missing or damaged, contact your Topcon dealer or Topcon technical support. See "Getting Technical Support" on page 3.

Technical Documents

The *Net-G5 Operator's Manual* and *Reference Card* are designed to help you set up and use your new receiver quickly and efficiently. You can download a digital copy of the *Net-G5 Operator's Manual* and *Reference Card* from the myTopcon website at <https://www.topconpositioning.com/support>.

TopNET+ Operator's Manual – An on-screen help document that contains detailed information on how to remotely configure your new receiver.

Topcon Receiver Utility (TRU) Online Help – Help documentation for TRU is embedded in the software; See "Using Topcon Software With Your Receiver".

Using Topcon Software With Your Receiver

TopNET+ software is a full-suite of GNSS Reference Network management tools that builds on TopNET RTK by adding Network RTK (model solution) to the available data services. It extends traditional RTK capabilities and significantly improves initialization times when the Rover is a long distance from the nearest reference station.

The Topcon Receiver Utility (TRU) is hardware configuration software for receivers and peripheral devices. You can install it on personal computers and data controllers. You can download the TRU software from the Topcon TotalCare website (www.topconcare.com). TRU *Help* is only available on the software.

Contact your Topcon dealer for more information about the Topcon software described above.

Getting Technical Support

Before contacting a Topcon customer representative about any problems with the receiver, see “Troubleshooting” on page 37 for some solutions that may fix the issue.

Contact your local Topcon dealer or visit the myTopcon Website (<https://www.topconpositioning.com/support>) for technical support.



For quick and effective support, provide a detailed description of the problem.

When contacting Topcon for technical assistance, provide the following information for better and faster service:

1. A description of the following:
 - Field operation that was being performed when the problem occurred
 - Details of the unexpected behavior, symptoms, and any error messages that precede or follow the problem
 - Problem occurrence frequency or patterns
2. Receiver information and configuration settings. For receiver information, click **Information** in TRU, select **Save to File**, enter a file name, and save it to the computer.
3. Specifications of mobile devices and computers used in the field or office exhibiting the problem. These specifications should include model information, version number, operating system information, memory and storage capacity, etc.
4. Information about the system software, including the version number and steps to reproduce the problem.
5. A description of the field environment and/or observation conditions when the problem occurred.

Website

The Topcon website provides current information about Topcon’s line of products. The support area of the website provides access to Topcon field and office software, manuals, frequently asked questions, and so forth. To access the Topcon website, visit www.topconpositioning.com.

The Topcon’s TotalCare website also provides complete support, such as news, updates, reminders, training, live Webinars, and customer service to help you get the information you need. Visit www.topconcare.com.

Getting Acquainted

The Net-G5 receiver enclosure is fully sealed and incorporates the GNSS receiver board, internal batteries, memory storage, and wireless communication devices. A flexible user interface enables you to connect the receiver with various external devices, such as computers, network devices, sensors, frequency sources, etc.

Receiver Housing Overview

The receiver's standard hardware configuration includes:

- three serial data ports
- a USB device and USB host ports
- an Ethernet port
- an interface for controlling and viewing data logging, link, and power status
- an SD card slot
- a SIM card slot
- an external GNSS antenna port
- a frequency input/output port
- a 1PPS port
- Event Marker port
- two internal batteries
- two power ports

Although this is the standard configuration, the OAF must enable some of these features for proper operation. See "About the OAF" on page 24 for details.

Front Panel View

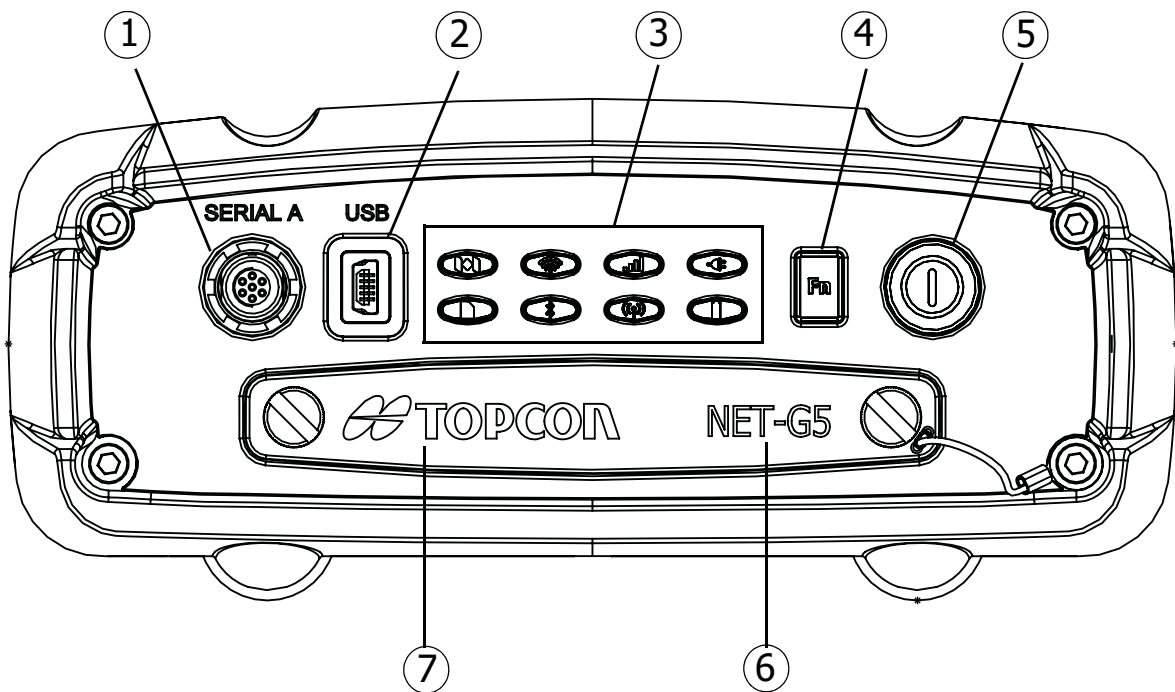

Figure 3: Receiver – Front Panel View

Table 1. Font Panel Ports

1	• Serial Port A (7-Pin ODU-MINI-SNAP) – Used for communication between the receiver and an external device.
2	• Mini USB – Used for high-speed data transfer and communication between the receiver and an external device.
3	• LED Display Panel – For LED descriptions, see "Display Panel" on page 9.

Table 1. Front Panel Ports

4	• FN Button – Turns data recording on and off.
5	• Power Button – Turns the receiver on and off; puts the unit in Sleep mode.
6	• SIM Card Slot – Resides on the front panel under the door and connects the SIM card to the receiver board to provide cellular connectivity.
7	• SD Card Slot – Resides on the front panel under the door and connects the SD card to the receiver board to provide memory.

Back Panel View

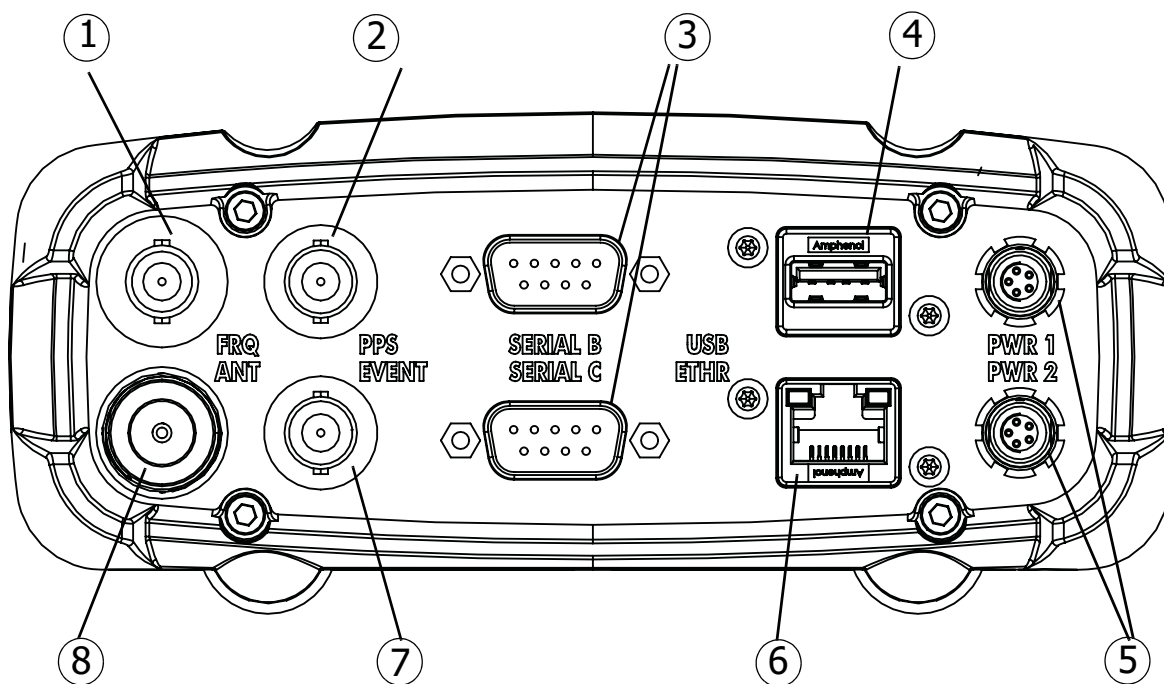
**Figure 4: Receiver – Back Panel View****Table 2. Back Panel Ports**

1	• External Frequency Port (BNC Connector) – Used for an external frequency input or the receiver’s internal frequency output.
2	• PPS Port (BNC Connector) – Used for generating one pulse per second signals with programmable reference time, period, and offset. The pulse is synchronized to a specified reference time.
3	• Serial Ports (x3) – Used for communication between the receiver and an external device. Ports A and B are RS-232. Port C is RS-422.
4	• USB Type A – Used for high-speed data transfer and communication between the receiver and an external device.
5	• Power Ports (x2) – Connects the receiver to external power sources. PWR1 supplies power to receiver and charges internal backup battery. PWR2 does not charge the batteries.
6	• Ethernet – Used to connect the receiver to a computer or network.
7	• Event Marker Port (BNC Connector) – Used to input an event synchronized with a specified time reference.
8	• GNSS Antenna Port (Type N Connector) – Used for detecting GNSS signals.

Cables and Power Supply

The Net-G5 package includes standard communication and power cables. Table 3 lists these cables.

Table 3. Receiver Package Cables

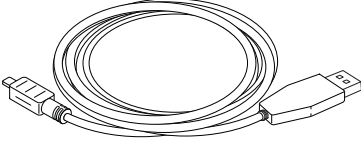
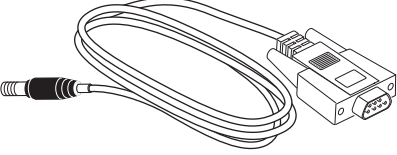
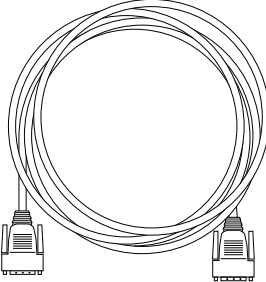
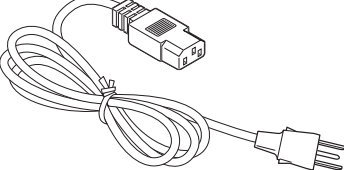
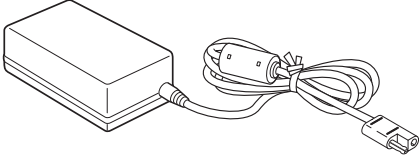
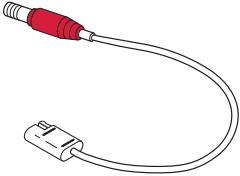
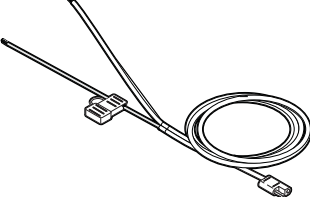
Cable Description	Cable Illustration
<p>USB Cable Connects the receiver to an external device (controller or computer) for high-speed data transfer and receiver configuration. p/n 14-008081-01 This can also be purchased at any local computer store, and must be high speed certified.</p>	
<p>Serial Cable Connects the receiver to an external device (controller or computer) for data transfer and receiver configuration. Body of connector is black. p/n 14-008005-03</p>	
<p>Null Modem Cable Connects the receiver with an external device (controller or computer) for data transfer and receiver configuration. p/n 14-008086-01 Can also be purchased at any local computer store.</p>	
<p>Power Cable Connects the power supply unit to a grounded outlet. U.S. p/n 1005793-01 Europe p/n 1005794-01</p>	
<p>Power Supply Unit Converts the alternating current (AC) supplied from an electrical outlet to a direct current (DC) for powering the receiver. The unit connects to the receiver via the receiver power cable (see the power related sections in "Using External Power Sources" on page 13). p/n 1005555-01</p>	
<p>Receiver Power Cable Connects the receiver and the power supply unit via SAE connectors. Body of connector is red. p/n 14-008016-04LF</p>	
<p>Fused Pigtail Cable Connects the receiver power cable via SAE connectors with a custom power supply unit via bare wires. p/n 14-008099-01</p>	

SD Card (Memory)

The receiver is equipped with a removable memory SD card that provides up to 32 GB of data storage. As data is logged to the memory card, the REC LED displays the memory capacity status. See "Recording LED" on page 11 for more information.

Insert the SD Card into the SD card slot located on the front panel under the door. Once installed, the SD card usually remains inside the receiver. You can access the data that resides on the card using the serial, USB, Ethernet ports, or the Vanguard web interface.

Installing the SD Card



To preserve data integrity, only install or remove the card when the receiver is powered off.

1. Make sure the receiver is turned off.
2. Make sure the card has been formatted for the FAT32 file system before first use. See "Formatting the SD Card" on page 7.
3. On the front panel, open the door by turning the two screws to the left.
4. Carefully insert the SD card, label side up, into the card slot as shown in Figure 5.
5. Make sure the bottom of the card is recessed before closing the receiver door.
Once the receiver is turned on, the receiver board detects the SD card and is ready for use.



Figure 5: Inserting an SD Card

Formatting the SD Card

The Net-G5 requires an external SD card formatted for the FAT32 file system. You can format the SD card using the internal disk management application provided by Microsoft; however, this application cannot create partitions larger than 32 GB. You can also format the card with PC running Windows, and then use the card in the receiver.

For more information about FAT32 limitations and formatting, go to <http://support.microsoft.com/kb/184006/en-us>. For partitions larger than 32 GB, use external disk partition software.

Formatting the SD card permanently erases all data on the card. Back up any necessary data before formatting the SD card.

Internal Batteries

The Net-G5 receiver was designed with internal, non-removable batteries, so there is no battery door or connectors to worry about. These batteries, when fully are easily charged using the supplied power adapter or an external power source. See "Internal Batteries" on page 14 for more information.

Display Panel

The Net-G5 receiver has a highly-visible display panel with single-button operation. The LED display panel enables you to control receiver power and data recording. The LEDs display the status of the satellite tracking, recording/memory capacity, wireless connections, and power. This chapter describes the different LED blink patterns and what they mean.

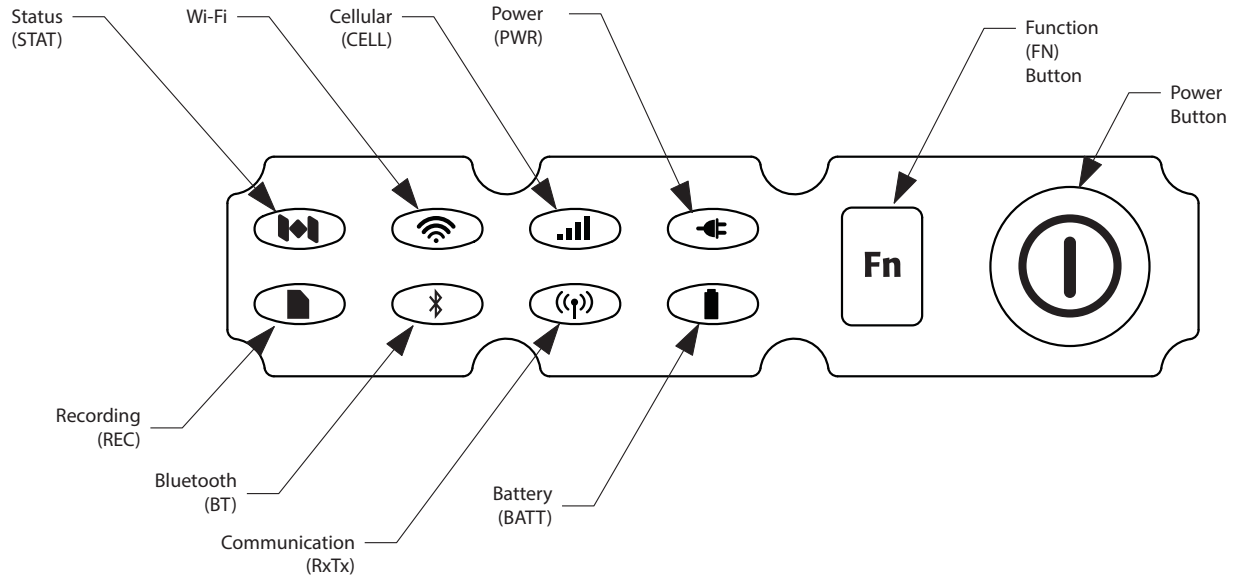

Figure 6: LED Display Panel

Power Button

The power button performs multiple functions. The duration in which the button is pressed and held determines how the receiver will perform. While pressing the button, the LED panel indicates the selected operation using particular LEDs. Table 4 describes how to use the power button.

Table 4. Power Button Features

FUNCTION	PRESS BUTTON	LED DESCRIPTION
Power On	1+ seconds	LEDs blink green until the startup is complete. LEDs return to normal and the Power LED is solid green, indicating that the receiver is on.
Power Off	3-10 seconds	All LEDs are off. Release the Power button when the Power LED is solid red. When no external power is present, the Power LED is dark.
Clear NVRAM		See "Resetting the Receiver (Clearing the NVRAM)" on page 30 for more information.

Function Button

Table 5. **Function Button Features**

FUNCTION	PRESS BUTTON	LED DESCRIPTION
RECEIVER IS OFF		
Power Off	Press button	No action.
RECEIVER IS ON		
Start/Stop Data Logging	1-5 seconds	<ul style="list-style-type: none"> • REC LED is green indicating data logging has started. • REC LED blinks green each time data is written to the receiver's memory. • REC LED is red when receiver is out of memory, has a hardware problem, or contains an improper OAF.
Toggle Post-Processing Mode	Less than 1 second	<ul style="list-style-type: none"> • Press for less than 1 second when "Occupation mode switch" has been enabled using TRU.
Change Information Mode	Three times for less than 3 seconds	<ul style="list-style-type: none"> • Press three times for less than 3 seconds when "LED blink mode switch" has been enabled using TRU.
Change Baud Rate of Serial Port	5-8 seconds	<ul style="list-style-type: none"> • After approximately 5 seconds, the REC LED becomes red. Release the Function button during the next 3 seconds.

Receiver Status LEDs

The status LEDs provide information about the battery life, tracked satellites, memory capacity, and wireless connectivity. This section describes the color and behavior of each LED.

Tracking Status LED

The tracking status LED displays what type of satellite the receiver is tracking.











Table 6. **Tracked Satellites**

Color	Description
Green	GPS
Yellow	GLONASS
Cyan	Galileo
Blue	SBAS/OMNI
Magenta	BeiDou
White	QZSS

Recording LED

The memory LED indicates if data is being written to memory and displays how much memory the receiver has available for recording.

Table 7. Recording LED Patterns



Display	Function	Description
  	Greater than 50% Greater than 10% Less than 10%	File logging is in progress. Each blink indicates data is being written to memory. When the receiver is in dynamic mode, the LED blinks twice every second. In static mode, the LED blinks once every second.
  	Greater than 50% Greater than 10% Less than 10%	The file is closed. A solid light indicates no data is being recorded.
 		Alternating green and red LEDs indicate all files are being deleted.
 		Alternating red and yellow LEDs indicate the memory card is being initialized or formatted.
	Missing or faulty memory	The LED is off.

Communication LEDs

The communication LEDs display the status of the wireless activity. The following tables describe the communication activity for four use cases: Bluetooth, Wi-Fi, and Cellular.



Bluetooth Only Status

Table 8. Bluetooth LED Patterns

LED Color	Description
	Bluetooth is on. Waiting for a connection.
	A single Bluetooth connection is established.
	Bluetooth is turned off.



Wi-Fi LED

Table 9. Wi-Fi LED Patterns

LED Color	Description
	The internal Wi-Fi modem is starting up.
	The internal Wi-Fi modem is transmitting or receiving data.

Cellular Status¹









Table 10. Cellular LED Patterns

LED Color	Description
	The cellular modem is starting up.
	The cellular modem is transmitting or receiving data.

Battery LED





The Battery LED indicates the remaining charge of the internal batteries. When an external power source is utilized, the LED turns green and begins to blink if the batteries begin to charge. See Table 11 for more information.

Table 11. Battery LED Patterns

LED Color	Description
THE RECEIVER IS ON; INTERNAL BATTERIES IN USE	
	The charge is greater than 50 percent.
	The charge is greater than 10 percent.
	The charge is less than 10 percent.
THE RECEIVER IS ON; EXTERNAL POWER IN USE; PWR LED IS SOLID GREEN	
	An external power source is in use, and the internal batteries are fully charged.
	The internal batteries are at greater than 50% capacity; the batteries are being charged.
	The internal batteries are at greater than 15% capacity; the batteries are being charged.
	The internal batteries are at less than 15% capacity; the batteries are being charged.
THE RECEIVER IS OFF	
	The receiver is connected to an external power source, and the batteries are fully charged.
	The receiver is connected to an external power source, and the batteries are being charged.

Power LED

Table 12. Power LED Patterns

LED Color	Description
	An external power source is in use and connected to the PWR1 bulkhead. The LED blinks green at 1 Hz intervals.
	An external power source is in use and connected to the PWR2 bulkhead. The LED blinks green at 2 Hz intervals.
	An external power source is in use and connected to the PWR1 and PWR 2 bulkheads.
	LED is dark when no external power source is connected.

1. Cellular modem functionality will be added in a later version of firmware.

This chapter describes how to power the receiver, charge the internal batteries, and use an external power source.

Turning On/Off the Receiver

To turn on the receiver, press and hold the power button until the LEDs briefly flash. When the receiver is turned on, the receiver's channels initialize and begin tracking all visible satellites at any time and location.

To turn off the receiver, press and hold the power button for more than three and less than 10 seconds (release the power button when the POWER LED blinks yellow). Allow the receiver to complete the power off cycle (approximately 30 seconds).



The receiver will draw a small amount of power from the batteries when it is turned off. If the receiver is placed in storage for a long period, such as a few months, the batteries may become fully discharged. You will need to use an external power supply or recharge the batteries before use.



The Linux operating system will cause a brief delay in the powering on and off of the receiver. When powering off, the Power LED will briefly blink yellow before shutting down.

Using External Power Sources

The Net-G5 receiver is designed to draw power from external power sources before drawing power from the internal backup batteries.

You can connect the receiver to an external power source, such as a vehicle battery, with 9 V to 28 VDC to operate the receiver. When setting up the receiver, consider the following powering requirements:

- Never use an extension cord for permanent power supply. This setup can create a fire hazard.
- Always use a grounded outlet.
- Use a surge protector to protect connected electronic devices.

See "General Details" on page 42 for more information on external power source requirements to power the receiver and charge the internal batteries.



Power input greater than 28 VDC could damage the receiver.

Powering the Receiver

The receiver has two power ports. PWR2 will not charge the batteries.

To power on the receiver:

1. Connect the power cable to the power supply unit.
2. Connect the SAE connectors on the power adapter cable and power supply unit.
3. Connect the power adapter cable to the PWR port on the receiver's rear panel.

4. Plug the power supply into an available outlet.

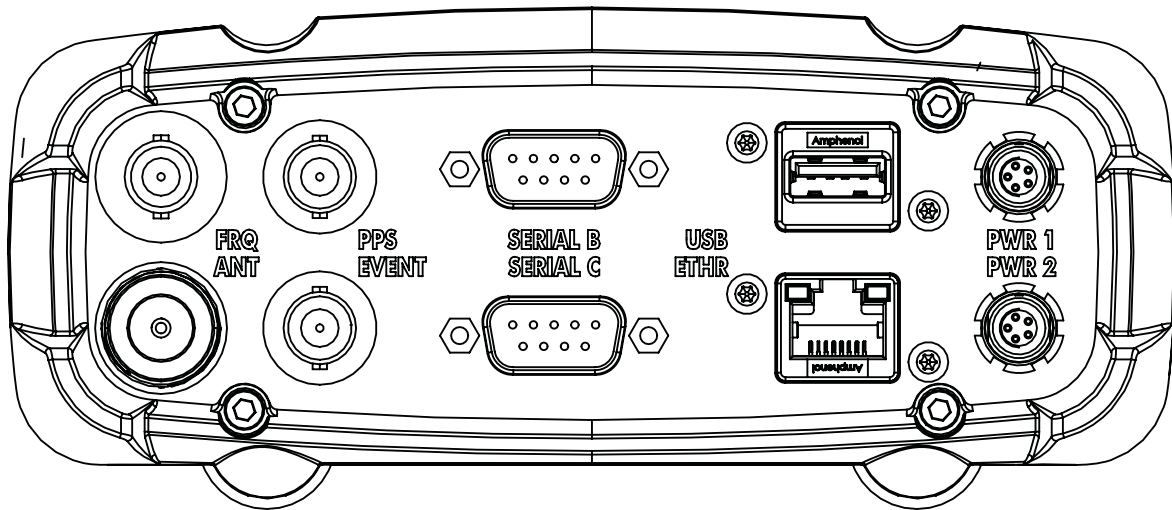

Figure 7: Connect the Receiver to a Power Source

Checking Power Status

You can check the receiver's power status using the PWR LEDs or available Topcon software. The power LEDs on the receiver indicate the following power status:

- Solid Green – power within the acceptable range (6–28 V DC) is present on both PWR1 and PWR2 ports and is being used to power the receiver.
- Solid Red – either a power failure has occurred with a connected power source or the port is not receiving power. For details, see "Insufficient Power" on page 15 and "Powering Problems" on page 37.
- Green blinks – power within the acceptable range (6–28 V DC) is present on this PWR port and is being used to power the receiver and to charge the corresponding battery.
- Red blinks – the corresponding backup battery is being charged.
- Off – the receiver consumes power from internal backup batteries or the receiver is turned off.

Refer to the TopNET+ software manual for details on checking the power status via installed software.

Internal Batteries

The receiver first draws power from a connected external power source. When there is no valid external power source connected or if the source has discharged lower than 6.5V, the receiver will draw its power from high-capacity internal batteries (non-removable). Depending on the use case, the hours of operation provided by the internal batteries vary.

Charging the Backup Batteries

When the battery charge is low, the BAT LED changes from solid green to yellow and then red, depending on the remaining charge (see "Battery LED" on page 12). When the receiver is connected to an external power source, the batteries begin to charge whether the receiver is turned on or off.

To charge the batteries:

1. Connect the supplied power cable to the receiver's power port.
2. Connect the power cable SAE connector to the SAE connector of the power adapter.
3. Plug the power adapter into an available outlet to fully charge the batteries. The batteries charge simultaneously. You cannot over charge the batteries; the batteries stop charging when they are full.) The BAT LED blinks as the batteries charge.



Use a grounded wall outlet or grounded surge protector while charging. The socket should be located near the equipment and easily accessible.



The backup batteries charge when the input voltage is between +9 and +28 V DC.

Insufficient Power

If the batteries become fully discharged and an external power supply is not connected, the receiver will shut down and automatically save recorded files. To avoid disruptions, check the BAT LED on the display panel for the battery charge status. See "Battery LED" on page 12 for more information.

If the receiver shuts down due to insufficient power, the receiver and all communication ports become deactivated.

To restore power to your receiver and turn it back on:

- Recharge the batteries.
- Make sure the power/serial cable is correctly connected to the receiver's port.
 - Align the keyways when connecting the power/serial cable to the receiver port.
 - Turn the cable lock clockwise until it clicks to secure the cable in place.
 - To disconnect the cable, turn the lock counter-clockwise, and then gently remove the cable.
- Connect the receiver to a different power source.



Power supplied to the receiver should match the specifications provided by Topcon on the product. Failure to comply with these specifications may damage the receiver.

Configuring the Receiver

The Net-G5 receiver is intended primarily for use as a permanent or semi-permanent GNSS Reference Station to establish networks supporting both real-time and post-processing applications. You can stream observation data through any port to any device capable of receiving and utilizing it, including TopNET+ reference station software. You can also log data internally to removable SD cards for downloading to support static or kinematic surveying, mapping, monitoring, and positioning applications.

The Net-G5 is configurable for single to multiple scenarios, including the following:

- permanent and semi-permanent Reference Station
- temporary campaign receiver
- RTK or DGPS rover (for monitoring a fixed location, system monitoring, or mobile data collecting)

The sections in this chapter describe receiver configuration, receiver options, loading a new Option Authorization File (OAF), updating firmware, and performing a factory reset. To do this, you will need to download the Topcon Receiver Utility (TRU) software from the myTopcon Website at <https://www.topconpositioning.com/support>. For information about installing the software, see the *Topcon Receiver Utility (TRU) Online Help*, available only in the software.

Configuring the Receiver

The Net-G5 is generally configured as a static Reference Station that collects GNSS measurement information and logs the data to a removable SD card, streams the data to a central computer, and possibly connects directly to one or more radios (or any combination of these configurations). The Topcon Receiver Utility (TRU) and TopNET+ software are used to manage and configure the various functions of the receiver. Configuration settings are saved to the NVRAM of the GNSS receiver board and are reflected when using the LED display panel.

The full range of both TRU and TopNET+ configuration and operation are outside the scope of this manual. For more information on any of the procedures in this section, or on TRU or TopNET+, refer to the appropriate manual available from www.topconcare.com, or embedded in TRU.

Once you have established a connection between the receiver and the computer, you will be able to:

- configure the receiver and its components
- send commands to the receiver
- download files from the receiver's memory
- load a new OAF and other configuration files to a receiver

Using the Web Interface

The Net-G5 includes a built-in Web server that allows you to configure and monitor the receiver via a Web browser. The following Web browsers are recommended for accessing the receiver:

- Windows Internet Explorer 6.0 or later
- Google Chrome
- Mozilla Firefox 2.0 or later
- Opera 9.0 or later

Accessing the Receiver Through the Web Browser

Before accessing the Net-G5 using the Web browser, determine whether the valid network parameters (IP address, gateway, etc.) are specified in the receiver. Refer to the *TRU Online Help* for details regarding the network parameters.

1. Open a recommended Web browser.
The browser window appears.
2. In the Address or Location bar of the Web browser, type one of the following addresses:
`http://ipaddress<:port number>` or `https://ipaddress<:port number>` (if SSL is enabled).

The *ipaddress* is the receiver's IP address; *port number* is the port number you should specify if set to a number other than the default port number (port 80 for HTTP, and port 443 for HTTPS).

Once the information is entered, the main page displays.



Figure 8: Vanguard Web Interface – Main Page



When accessing the Web interface via SSL communications, a warning may appear stating the security certificate was issued by a company you have not chosen to trust. You can safely ignore this warning and continue with the login procedure. Your communications will use SSL.

3. Enter the login name and password to access the Web interface. The default login and password are *admin*. Login names and passwords are case sensitive, and can be up to 12 alphanumeric characters.

Figure 9: Vanguard Web Interface – Login

4. Click **LOGIN**.
After logging in to the Web interface, you can view and modify the receiver parameters.



You can access the receiver without entering the login name and password; however, you will be restricted to view-only activities.

Net-G5 Web Interface Ports

Although not necessary for functionality, you can configure the following ports to use with the Net-G5 Web interface.

- TCP 80 - HTTP
- TCP 8888 - web socket
- TCP 21 - FTP
- TCP 23 - Telnet
- TCP 8002 - GRIL port

If you are accessing the Web interface from behind a firewall or router, open and forward each port to the receiver's IP address.

Viewing Receiver Information

In the Topcon Receiver Utility (TRU), the **Receiver Info** window displays basic Receiver information, such as hardware and firmware versions, RAM size, receiver ID, serial number, etc.

To open the Receiver Info window:

1. Connect the receiver to a computer and open TRU.
2. In TRU, connect to the receiver.
3. Click **Device** ▶ **Application Mode** ▶ **Receiver Managing**.
4. Click **Device** ▶ **Connect**.
5. In the **Connection Parameters** window, select the correct serial port, and click **Connect**.
6. In the TRU main window, click the **Information** icon. The **Receiver Info** window (Figure 10) appears.

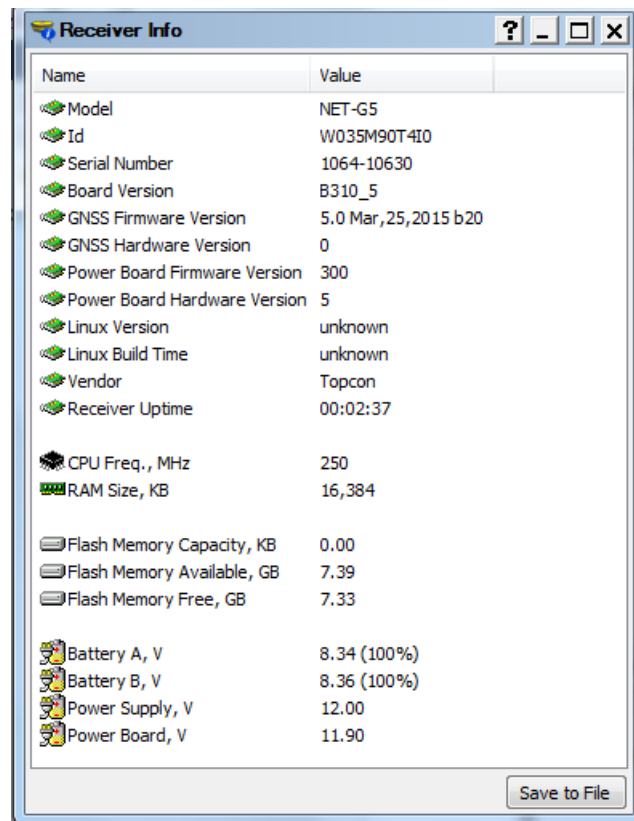

Figure 10: TRU – Receiver Info

Updating Firmware

Update Firmware Using TRU

The following describes how to update firmware on the Net-G5 using a network connection. You can also update the firmware using a Bluetooth, USB or a serial connection. To connect the receiver with a computer using a USB connection, you will need to install a USB driver. USB drivers and firmware are available at www.topconcare.com.

Receiver board firmware is released as a compressed *.tar file uploaded using TRU, TopNET+, or FTP.

Connect to the Receiver

1. In TRU, click **Device ▶ Application Mode ▶ Receiver Managing**.
2. Click **Device ▶ Connect**. The **Connection Parameters** screen appears.
3. Select **Network** from the **Connect Using** drop-down list, then click the dialog button from **Device Name** (Figure 11). The **Select Network Device** screen appears.

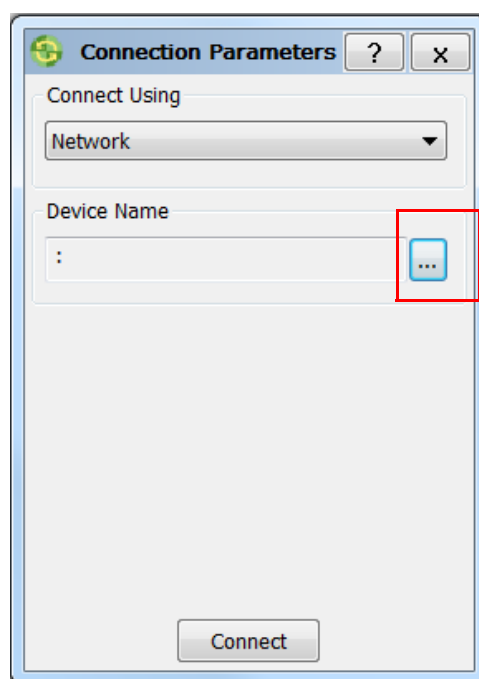

Figure 11: Connect to the Device Using Your Network

- Right-click in the **Select Network Device** screen, and click **Add** (Figure 12). The **Network Connection** screen appears.

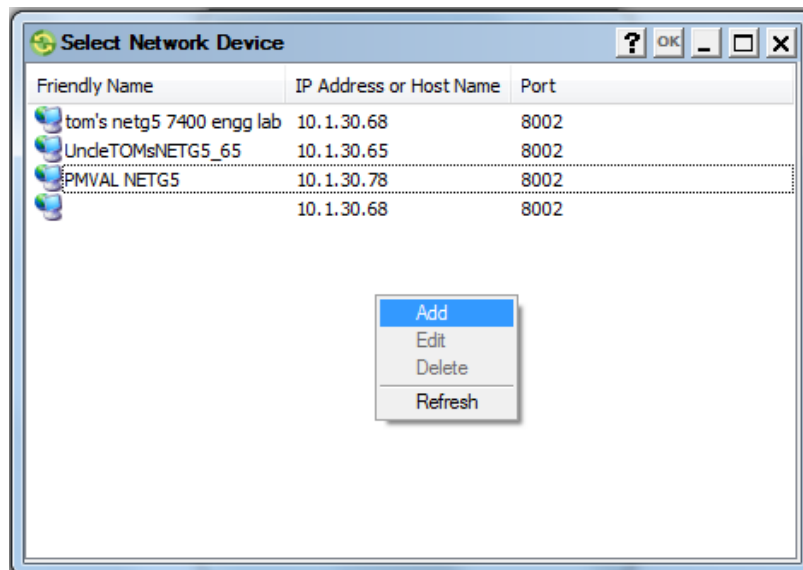

Figure 12: Select Add to Add a Device

- Enter the appropriate information for **Friendly Name**, **IP Address or Host Name**, **TCP Port**, and **Password**, then click **OK** (Figure 13). The **Select Network Device** screen appears.

Figure 13: Enter the Information for the Device

- Click **OK** on the **Select Network Device** screen. The **Connection Parameters** screen appears.

- Click **Connect** (Figure 14).

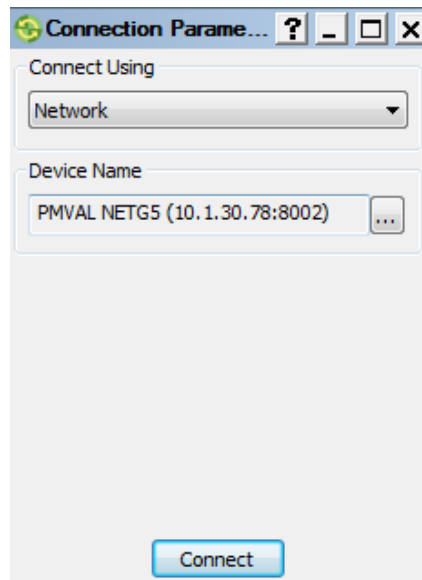

Figure 14: Connect to the Device

Load the Firmware

- In TRU, click **File Explorer**. The **File Explorer** screen appears.
- Click the **Files** tab.
- Right-click in the **File Explorer** screen, and click **Open in Windows Explorer** ▶ **SD Card** (Figure 15). An instance of Windows Explorer will open.

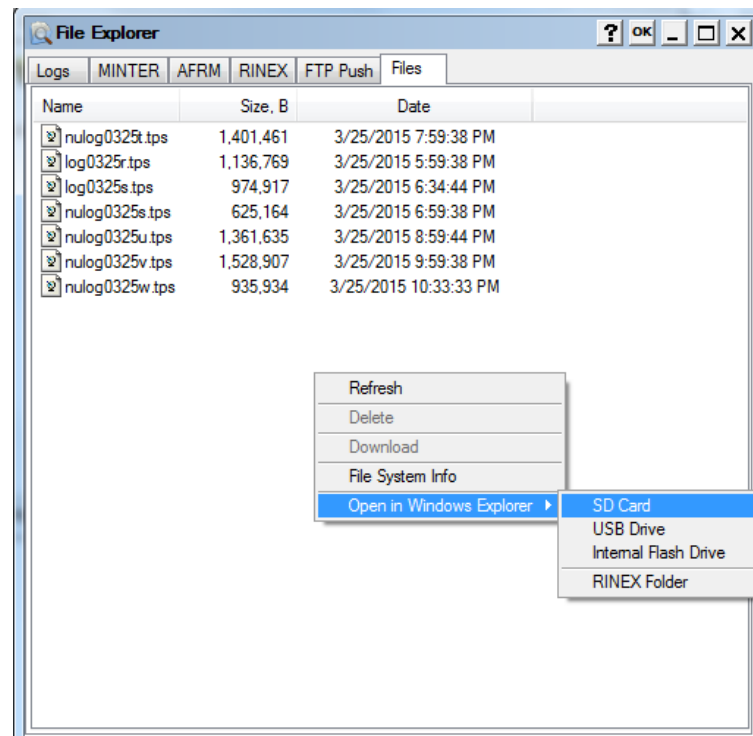

Figure 15: Open the SD Card in Windows Explorer

4. Open the **b310.update** folder in Windows Explorer, and delete any content in the folder (Figure 16).

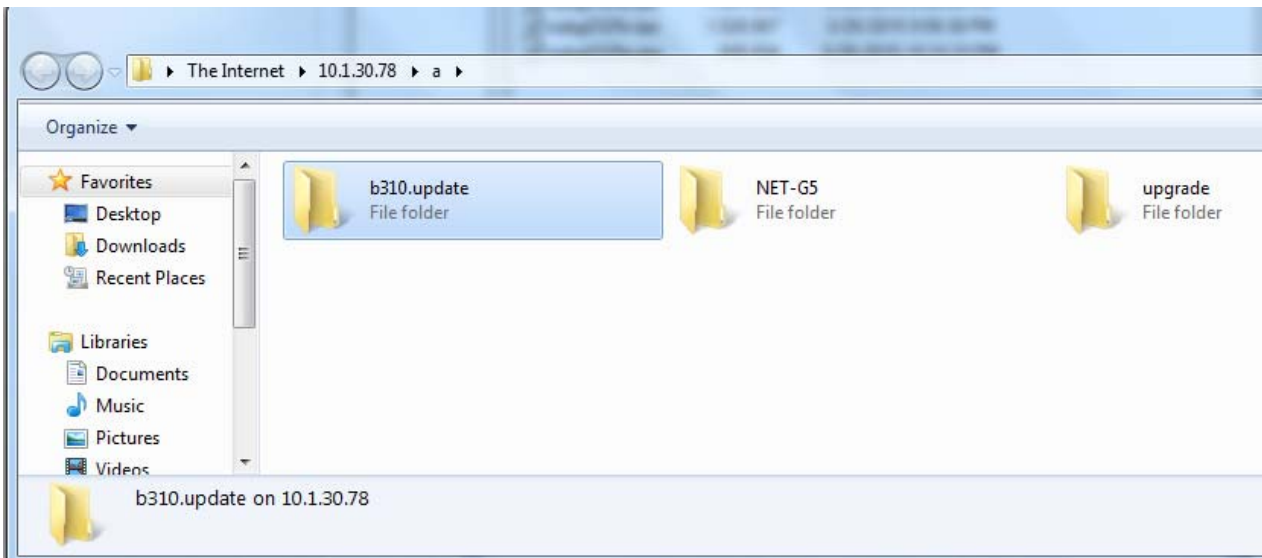

Figure 16: Delete the Contents from the b310.update folder

5. Open another instance of Windows Explorer and locate the appropriate *.tar file (Figure 17).

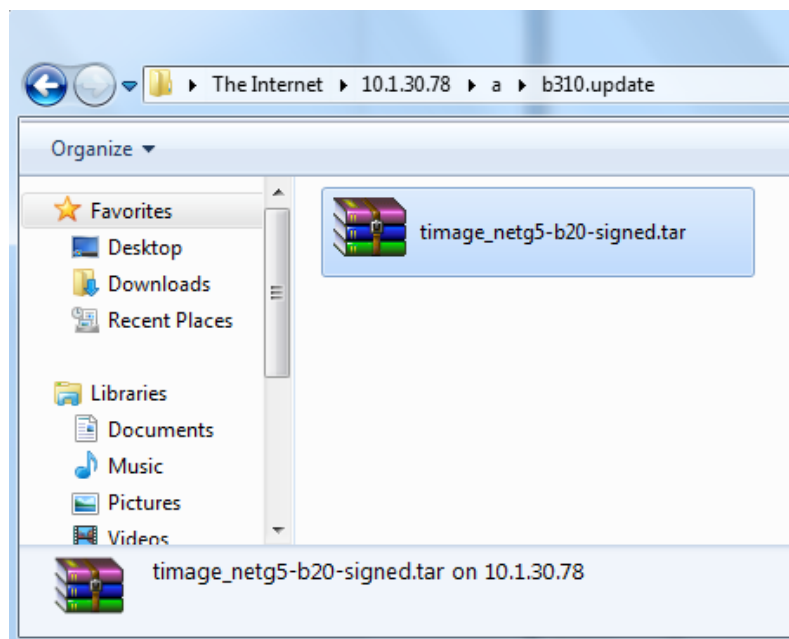

Figure 17: Locate the Firmware File

6. Drag the *.tar file into the **b310.update** folder, and close both Windows Explorer windows.
7. Click **OK** in the TRU **File Explorer** screen. The TRU main screen appears.
8. Click **Terminal**. The **Terminal** screen appears.

- Enter `%%set,update,yes` in the command prompt, and click **Send** (Figure 18).

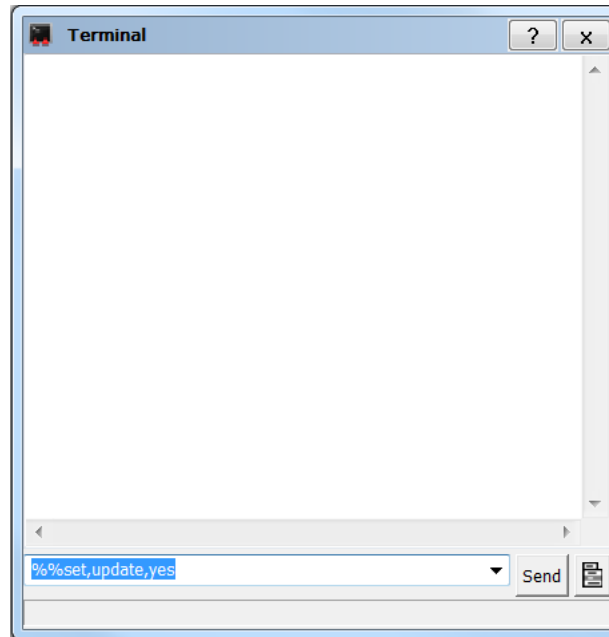

Figure 18: Send the Update Command

During installation, the Power LED will blink yellow-green. After installation, the Power LED will be solid green. Once the Power LED is solid green, close the **Terminal** screen and click **Device ▶ Disconnect** in TRU.

Verify Firmware Upload

- In TRU, click **Device ▶ Connect**. The **Connection Parameters** screen appears.
- Click **Connect**. The TRU main screen appears.
- Click **Information**. The **Receiver Info** screen appears showing the current firmware loaded to the device (Figure 19).

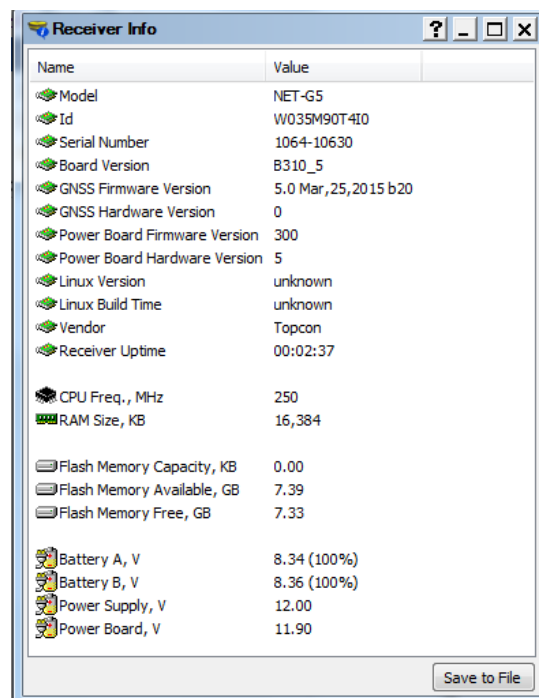

Figure 19: Receiver Info Displays the Current Firmware

Update Firmware Using an SD Card

Install Firmware Installation File

The following process can be done by removing the SD card from the receiver, or connecting to it using FTP, TRU, or TopNet+.

1. Connect to the receiver or remove the SD card, and insert it into a computer.
2. Locate and open the **b310** sub-folder on the SD card.
3. Verify that a **b310.update** folder is present. If not, create the folder.
4. Locate and copy your ***.tar** firmware installation file to the **b310.update** folder.
5. If you removed the SD card from the receiver in Step 1, insert the card into the receiver. Otherwise, disconnect from the receiver.

Begin Firmware Update

Open the GRIL terminal and send the command *%%set,update,yes*. The update will take up to 10 minutes to complete. During installation, the Power LED will blink yellow-green. After installation, the Power LED will be solid green. Once the Power LED is solid green, connect to the receiver using TRU and verify that the correct firmware is installed (see "Verify Firmware Upload" on page 23).

About the OAF

Topcon issues an Option Authorization File (OAF) to enable the specific options that you purchased. Topcon's OAF system allows you to customize and configure the receiver according to your particular needs, therefore purchasing only the options you require.

The Net-G5 receiver typically ships with an OAF as per initial purchase of the receiver kit configuration. There are several upgrade options available with the receiver that can extend the receiver's functionality to better suit your job requirement. Examples of upgrade options are listed below:

- Standard Options
- GPS
- GLONASS
- GPS + GLONASS dual frequency static operation
- GALILEO
- BeiDou
- QZSS
- 50HZ
- 100HZ
- Additional external frequencies

Contact your Topcon dealer or a representative for a complete listing of available options and pricing information.

Checking the Receiver's OAF

To use TRU to view the status of the receiver's options:

1. Connect the receiver to a computer and open TRU. See the *Topcon Receiver Utility (TRU) Online Help* for more information about connecting the receiver to a computer.
2. In TRU, connect to the receiver.
3. Click the **Options**  icon in the main window. The **Receiver Options** window (Figure 20) displays, so you can view the current authorization options and upload new ones.

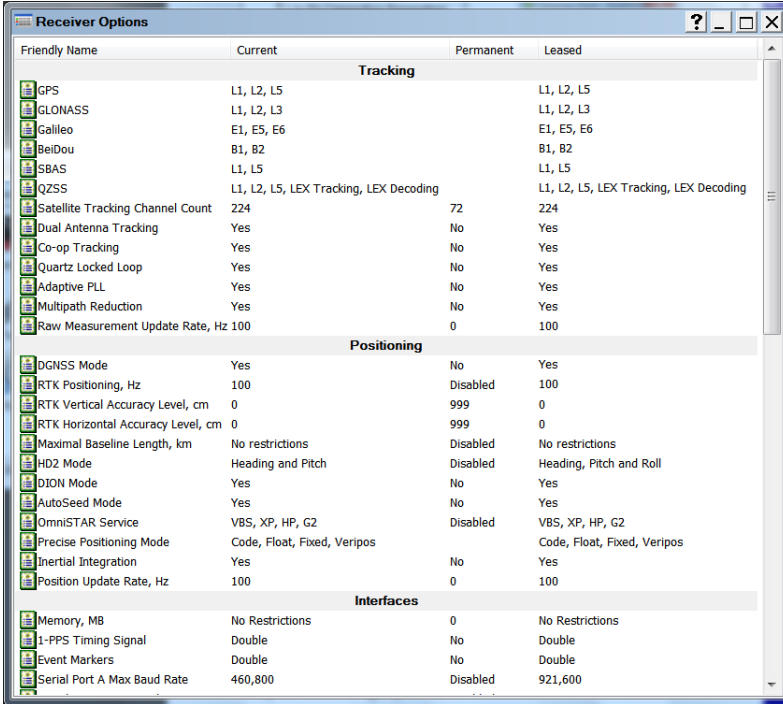

Friendly Name	Current	Permanent	Leased
Tracking			
GPS	L1, L2, L5		L1, L2, L5
GLONASS	L1, L2, L3		L1, L2, L3
Galileo	E1, E5, E6		E1, E5, E6
BeiDou	B1, B2		B1, B2
SBAS	L1, L5		L1, L5
QZSS	L1, L2, L5, LEX Tracking, LEX Decoding		L1, L2, L5, LEX Tracking, LEX Decoding
Satellite Tracking Channel Count	224	72	224
Dual Antenna Tracking	Yes	No	Yes
Co-op Tracking	Yes	No	Yes
Quartz Locked Loop	Yes	No	Yes
Adaptive PLL	Yes	No	Yes
Multipath Reduction	Yes	No	Yes
Raw Measurement Update Rate, Hz	100	0	100
Positioning			
DGNSS Mode	Yes	No	Yes
RTK Positioning, Hz	100	Disabled	100
RTK Vertical Accuracy Level, cm	0	999	0
RTK Horizontal Accuracy Level, cm	0	999	0
Maximal Baseline Length, km	No restrictions	Disabled	No restrictions
HD2 Mode	Heading and Pitch	Disabled	Heading, Pitch and Roll
DION Mode	Yes	No	Yes
AutoSeed Mode	Yes	No	Yes
OmniSTAR Service	VBS, XP, HP, G2	Disabled	VBS, XP, HP, G2
Precise Positioning Mode	Code, Float, Fixed, Veripos		Code, Float, Fixed, Veripos
Inertial Integration	Yes	No	Yes
Position Update Rate, Hz	100	0	100
Interfaces			
Memory, MB	No Restrictions	0	No Restrictions
1-PPS Timing Signal	Double	No	Double
Event Markers	Double	No	Double
Serial Port A Max Baud Rate	460,800	Disabled	921,600

Figure 20: Receiver Options



You can also check the receiver's OAF using TopNET+ or the Vanguard web interface.

Loading an OAF

Topcon dealers provide customers with OAF files. For any OAF related questions, e-mail Topcon at options@topcon.com and include the receiver's ID and serial number. To obtain these numbers, see "Viewing Receiver Information" on page 18.

To load a new OAF:

1. Follow the steps in "Checking the Receiver's OAF" on page 25.
2. Right-click on the **Receiver Options** window, and select **Upload OAF**.(see Figure 21).

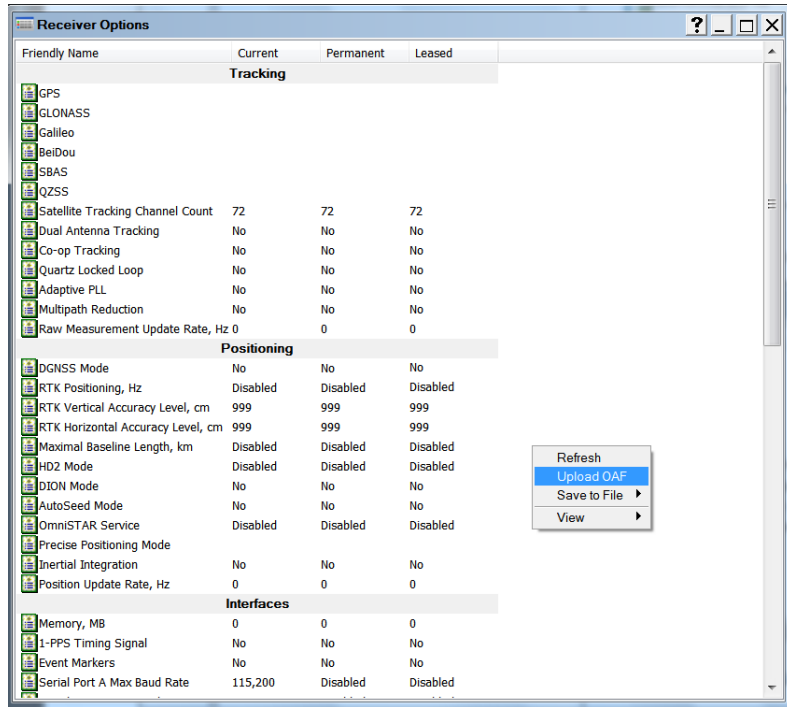

Figure 21: Right-click and Select Upload OAF

3. Navigate to the location of the new Option Authorization File.
4. Select the appropriate file, and click **Open** (Figure 22).

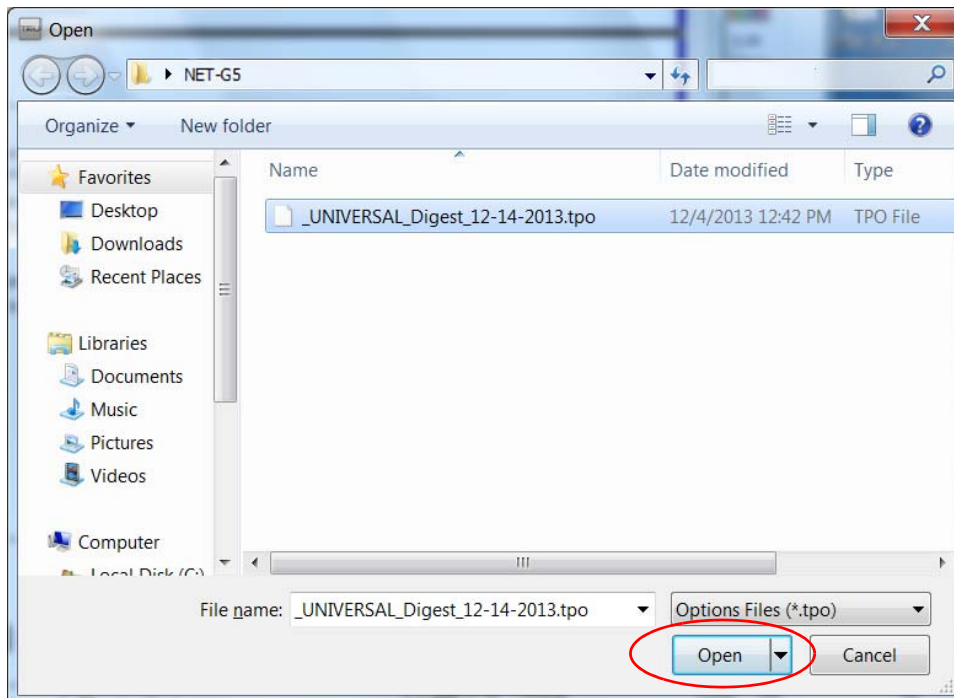

Figure 22: Load OAF

Topcon's TRU initially checks to see if the selected file is compatible with the currently connected receiver. If you chose a file not intended for this receiver, the **Upload OAF** window displays an error icon next to the Receiver ID and disables the **Upload the File to the Receiver** button.

- Click **Upload the File to the Receiver** to start loading the file (Figure 23).

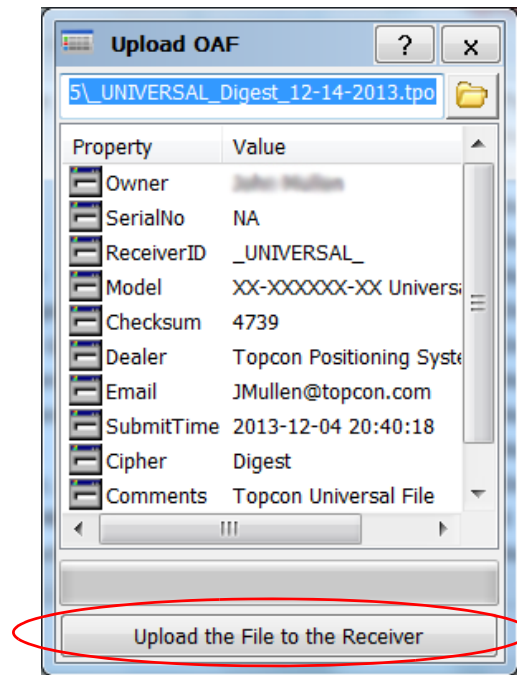

Figure 23: Upload the OAF to the Receiver

- Click **Yes** at the prompt to reset the receiver (Figure 24).

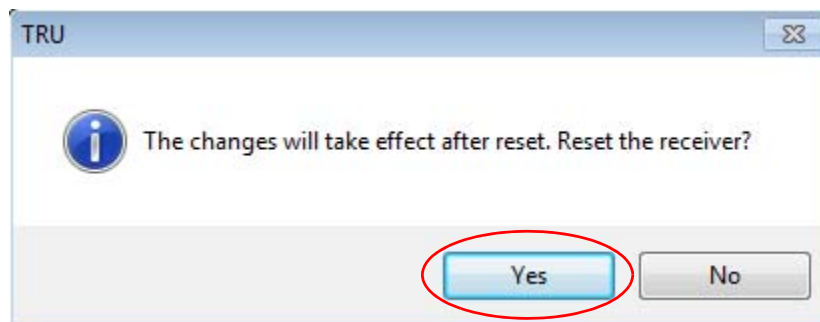

Figure 24: Reset Receiver

When the receiver resets, the **Connection Parameters** window opens.

7. Click **Connect** (Figure 25). The TRU main window appears.

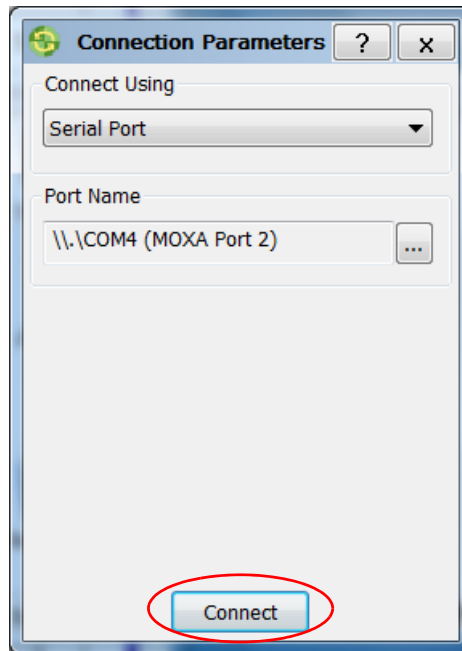

Figure 25: Connect to the Receiver

8. Click **Options** (Figure 26). The **Receiver Options** window displays.

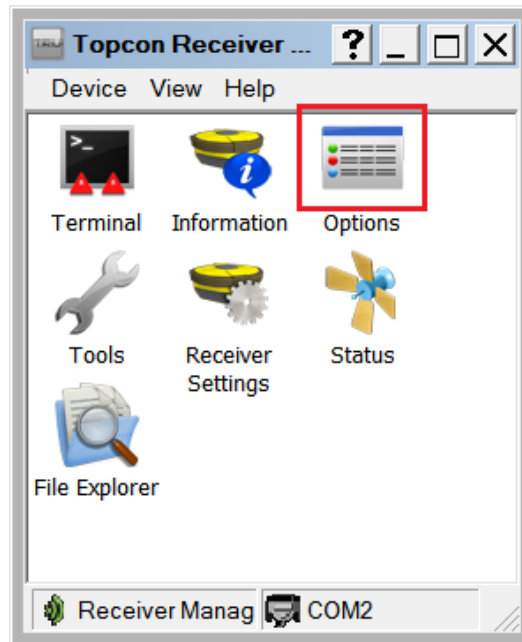

Figure 26: Click Options

In the **Receiver Options** window (Figure 27), ensure the following are correct:

- If you uploaded a universal OAF, make sure the expiration date is still valid.
- If you uploaded a customer OAF, make sure the correct customer file is loaded.

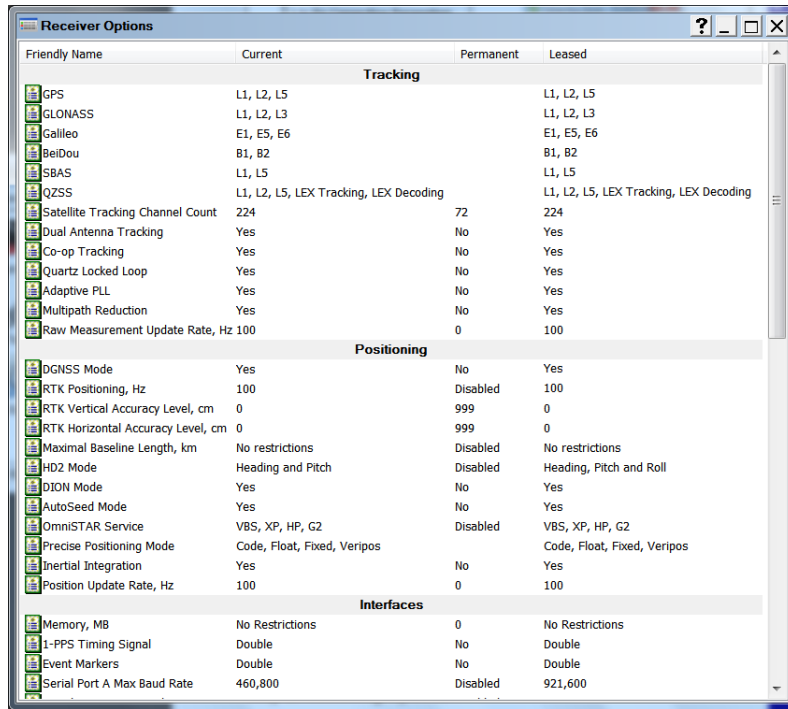

Figure 27: Receiver Options Window

To view additional OAF details, right-click in the **Receiver Options** window and select **View ▶ Details** (Figure 28).

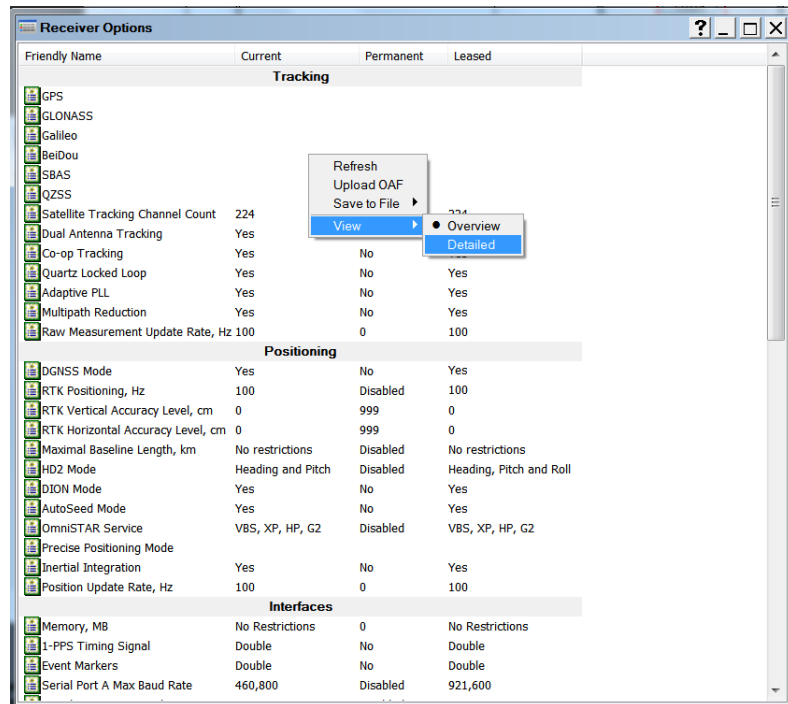

Figure 28: Additional OAF Details

Resetting the Receiver (Clearing the NVRAM)

The receiver's Non-Volatile Random Access Memory (NVRAM) holds data required for satellite tracking, such as ephemeris data and receiver position. The NVRAM also keeps the current receiver's settings, elevation masks, recording interval, and information about the receiver's internal file system. Clearing the receiver's NVRAM resets the receiver and restores the factory default settings.

Although performing a "factory reset" of the receiver is not recommended as a common practice, there are times when it can eliminate communication or tracking problems.

After performing a reset, the receiver requires time to collect new ephemerides and almanacs (around 15 minutes).

Resetting the receiver will not delete any files already recorded in the receiver's memory, and the NVRAM keeps information about the receiver file system.

To clear the NVRAM:

1. Power off the receiver.
2. Press and hold the Function button.
3. Press and release the Power button for one second.
4. Verify that the Tracking Status LED is solid green.
5. When the Tracking Status LED blinks orange, release the Function button.

You can also use TRU to clear the NVRAM:

1. Connect the receiver to a computer, and open TRU. See the *Topcon Receiver Utility (TRU) Online Help* for more information about connecting the receiver to a computer.
2. In TRU, connect to the receiver.
3. Click the **Tools** icon  in the main window.

The **Tools** window appears, enabling you to reset the receiver and clear the NVRAM.

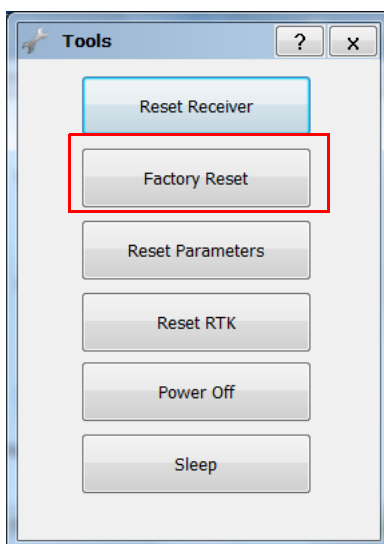

Figure 29: Tools Dialog Box

4. Click **Factory Reset**, and then click **Yes** to continue.

For a typical permanent or semi-permanent Reference Station setup, place the Net-G5 receiver in a secure location with access to power and communication links as required. Survey the antenna location very accurately, making sure the receiver is free of signal obstructions and interference (RF, multipath, etc.).

As a temporary Reference Station, certain steps must be performed to ensure proper data collection. The following steps detail the use of the Net-G5 in a temporary Reference Station setup.

Before logging data, make sure the receiver contains current almanac and current ephemeris data.

Step 1: Setting Up the Receiver

1. Place the receiver in the predetermined location. A sturdy shelf or out-of-the-way table may be a convenient spot.
2. For a permanent mount, drill four screws through the mounting location (shelf) and into the receiver's mounting holes.
3. Connect the power cable to an available and grounded outlet. See "Powering the Receiver" on page 13 for more details and precautions.
4. Connect the antenna cable. If recording data to an external device, such as a USB hard drive, connect it to the receiver using the required communication cable.

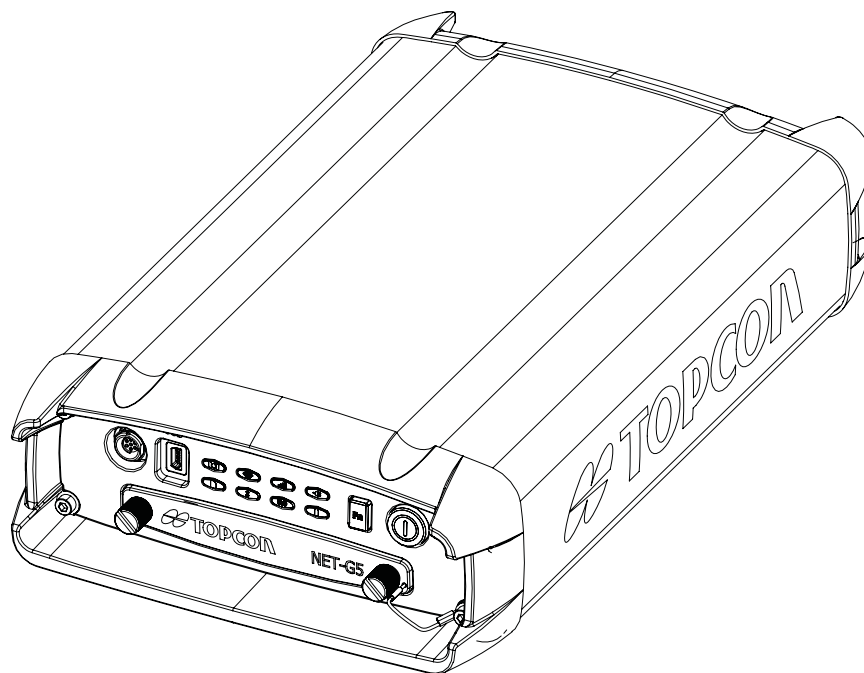

Figure 30: Mount Receiver and Connect Cables

Step 2: Measure Antenna Height

The location of the antenna relative to the point being measured is very important for both surveys in which the elevation of the point is important and in surveys for horizontal location only. Horizontal surveys are often larger in area than can reliably fit on a flat plane; therefore, the antenna adjustment must be done in three dimensions and then projected onto a two dimensional plane.

The receiver calculates the coordinates of the antenna's phase center. To determine the coordinates of the station marker, the user must specify the following:

- Measured height of the antenna above the station marker
- Method of measuring the antenna height
- Model of the antenna used

Antennas have two types of measurements:

- Vertical – measured from the marker to the antenna reference point (ARP) located on the bottom of the antenna at the base of the mounting threads.
- Slant – measured from the marker to the lower edge of the antenna slant height measure mark (SHMM).

The point to which all measurements are being referenced is called the Phase Center of the antenna. This is analogous to the point at which a distance meter measures in a prism. A user must enter the prism offset to compensate for this point not being at a physical surface of the prism. For a GNSS antenna, the offset is entered depending on the type of measurement taken.

- For vertical, the offset is simply added to the measured vertical height to produce a "true" vertical height.
- For slant height, the vertical height must first be calculated using the radius of the antenna, then the offset can be added.

The offsets are different because of the difference in location between the slant measuring point and the vertical measuring point.

1. Measure the antenna height above the control point or marker, either the slant height or the vertical height (Figure 31).
2. Record the antenna height, point name, and start time in the field notes.

The height of the antenna and its offsets depend on the type of antenna used. Refer to the antenna's documentation for details.



Refer to the antenna's offset measurements card for measurement and offset details.

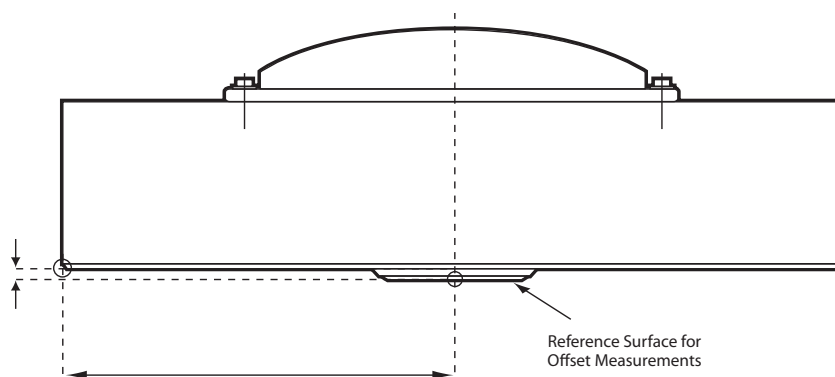

Figure 31: Measure Antenna Height – Example

Step 3: Collecting Data

See the remaining sections in this chapter for more information about collecting data.

1. Turn on the receiver. The STAT (status) light LED blinks red at first.
 - Once the receiver has locked on to one or more satellites, the STAT LED will blink green for GPS satellites and orange for GLONASS satellites. Other satellites will have different colors; see "Tracking Status LED" on page 10 for more information.
 - A short red blink indicates that the receiver has not solved a position. Four or more satellites provide optimal positioning.
 - Once the short red blink is gone, the receiver has a position and surveying can begin; wait for green and orange lights before beginning data collection. This ensures that the receiver has the correct date and time and is locked on to enough satellites to ensure good quality data.
 - The process of locking on to satellites normally takes less than one minute. In a new area or after resetting the receiver, it may take several minutes.
2. Press and hold the **FN** key for 1-5 seconds to begin collecting data.
3. Release the **FN** key when the REC (recording) LED turns green. This indicates that a file has opened and data collection has started. The REC LED blinks each time data is saved to the memory.



To configure data logging, see "Display Panel" on page 9 or refer to the *TRU Online Help*.

Step 4: Stop Data Logging

Stop logging data when you need to move the receiver, download data, or perform maintenance functions.

1. Press and hold the **FN** key until the REC LED light goes out.
2. To turn off the receiver, press and hold the power button for more than three and less than 10 seconds (release the power button when the POWER LED blinks yellow). Allow the receiver to complete the power off cycle (approximately 30 seconds).

Static Surveying for Reference Stations

Static surveying is the classic survey method, well suited for all kinds of base station surveys. One receiver over a survey marker collects raw data during a certain period of time. The length of the observation sessions can vary from a few minutes to several hours. The optimal observation session length depends on the surveyor's experience as well as the following factors:

- the number of satellites in view
- the satellite geometry (DOP)
- the antenna's location
- the ionospheric activity level
- the types of receivers used
- the accuracy requirements
- the baseline length

Generally, single-frequency receivers are used for baselines with lengths that do not exceed 15 kilometers (9.32 miles). For baselines of 15 kilometers or greater, use dual-frequency receivers.

Dual-frequency receivers have two major benefits. First, dual-frequency receivers can estimate and remove almost all ionospheric effect from the code and carrier phase measurements, providing much greater accuracy than single-frequency receivers over long baselines or during ionospheric storms. Secondly, dual-frequency receivers need far less observation time to reach the desired accuracy requirement.

After the survey completes, data the receivers collect can be downloaded onto a computer and processed using post-processing software (for example, Topcon Tools).

Analyzing Signal-to-Noise Ratio

Knowing the strength and reliability of the ranging signal transmitted from the satellites will help determine the quality of the satellite signals. Use Table 6-1 to help estimate signal quality from a satellite vehicle.

Table 6-1. Typical SNR Values

SV ^a Elevation (degrees)	C/A channel (dB*Hz)	P1 channel (dB*Hz)	P2 channel (dB*Hz)
10–20	>35	>10	>10
20–40	>40	>20	>20
40–60	>45	>30	>30
60–90	>50	>40	>40

a. SV = satellite vehicle

If the SNR value of a satellite signal is less than the threshold value from the table, then pay close attention to this satellite because it can potentially cause problems for getting accurate timing and positioning results.

Collecting Almanacs and Ephemerides

Each satellite broadcasts a navigation message that includes the ephemeris parameters of the satellite, the almanac, and various other information. The ephemeris parameters describe the orbital motion of the satellite and are used to predict its location/trajectory. The almanac gives the approximate orbit (course) for the transmitting satellite and all other satellites in the same system only.

- GPS and GLONASS satellites broadcast ephemeris data cyclically within 30 seconds.
- GPS satellites broadcast almanac data cyclically within 12.5 minutes; GLONASS satellites broadcast almanac data cyclically within 2.5 minutes.

When the receiver has an almanac, you can considerably reduce the time needed to search for and lock onto satellite signals.

The receiver regularly updates the almanac and ephemerides and stores the most recent versions in its Non-Volatile Random Access Memory (NVRAM).

You need to collect or update the almanac and ephemerides under the following circumstances:

- If the receiver has been off for a long time.
- If the last known receiver position, stored in the NVRAM, is different from the present position by several hundred kilometers.
- After loading a new OAF.
- After loading new firmware.
- After clearing the NVRAM.

To collect almanacs and ephemerides:

1. Set up the receiver.
The external antenna should be in a location with a clear view of the sky.
2. Turn on the receiver.
3. Wait for about 15 minutes while the receiver collects complete almanac and ephemeris data from the satellites.



If 15 minutes have passed and the receiver does not lock onto satellites, then clear the NVRAM. See “Resetting the Receiver (Clearing the NVRAM)” on page 30 for details.

This chapter provides general information about recording data, downloading it, and removing files to free up internal memory.

Setting Recording Parameters

The Topcon Receiver Utility (TRU) software enables you to set logging parameters, such as logging rate and types of messages, in which to record data. See the *TRU Online Help* for more information. TRU *Help* is only available in the software. Additionally, you can use TopNET+ or the Vanguard web Interface.

The Net-G5 is also compatible with any Topcon field software for configuration and recording raw data.

Using the Vanguard Web Interface

The Net-G5 includes a built-in Web server that allows you to configure and monitor the receiver via a Web browser. the following Web browsers are recommended for accessing the receiver:

- Windows Internet Explorer 6.0 or later
- Google Chrome
- Mozilla Firefox 2.0 or later
- Opera 9.0 or later

The built-in Web server and

Logging Rates

The receiver provides up to 32 GB of file space on the internal (non-removable) memory card. The amount of memory used to log data depends on the logging rate. For more information about setting logging rate parameters, see the *TRU Online Help*, which is embedded in the software.

Recording Data

You can log raw GNSS data to the receiver's internal memory and use the Topcon Receiver Utility (TRU) or TopNET+ software to download the files to a computer.

To start or stop recording data to the receiver, you can use the LED display panel or TRU:

1. Press the Power button to turn on the receiver.
2. Wait for the STAT LED to indicate satellites are being tracked. The STAT LED blinks green for GPS satellites and amber for GLONASS satellites. A short red blink indicates the receiver has not solved a position. Five or more satellites provide optimal positioning.
3. Press the Function button for one to five seconds to begin recording. You can also select **File Explorer** ▶ **Logs** ▶ **Start** in TRU to begin recording data.
4. Make sure the REC light is blinking green. This indicates that a file has opened and data collection has started. The REC LED blinks each time data is saved to the internal memory.
5. When you have finished recording, press the POWER button three times within two seconds, and make sure the REC LED is dark. You can also select **File Explorer** ▶ **Logs** ▶ **Stop** in TRU to end data recording.
6. To turn off the receiver, press and hold the POWER button for 3 to 10 seconds until all LEDs turn dark and the BAT LED is solid red.



You can also log data using MAGNET Field software.

Managing Files

Raw data is recorded as time-tagged measurements in a single raw data file. Each file is recorded to the receiver's internal memory, and automatically given a name and a *.tps file extension. You can then transfer a file of collected data to a computer with file managing software, such as the Topcon Receiver Utility (TRU). This program allows you to use an automatic naming feature, enter file names, and delete files as necessary. For more information, see the *TRU Online Help*, which is available in the TRU software.

Downloading and Deleting Files

You can download data files to a computer or a controller for storage, post-processing, or backup. The memory card holds a finite amount of files, so you will want to delete files to restore memory capacity.

When the memory card is full, the receiver stops logging data, and the REC LED turns dark/off, indicating an error condition. Existing data is not overwritten, unless you have the AFRM mode enabled.

To delete raw data files from the receiver, use a USB, serial, Wi-Fi, or Bluetooth connection to download the files to a computer. In TRU, you can select the files you want to delete from the receiver. See the *TRU Reference Manual* for more information or *TRU Help*, which is available on the software.

Once a connection is established, you can download all or some files to a computer or controller and then use the File Explorer feature in the Topcon Receiver Utility (TRU) to manage the raw data files. For more information about using TRU to download or delete files, see the *Topcon Receiver Utility (TRU) Online Help*, which is available in the software.

If you use the Net-G5 as a reference station in a network, you can use TopNet+ or the Vanguard web interface for downloading files.

This chapter will help you diagnose and solve some common problems that may occur with the receiver.



Do not attempt to repair equipment yourself. Doing so will void the warranty and may damage the hardware.

Check This First!

Before contacting your local dealer or Topcon Technical Support, check the following:

- Check all external receiver connections carefully to ensure correct and secure connections. Double check for worn or defective cables.
- Check the receiver's internal batteries for a full charge.
- Check the power source for incorrectly connected cables, and ensure the power source is valid. See "Specifications" on page 42 for external power requirements.
- Check the software. Make sure the most current software version is downloaded onto the computer and the most current firmware is loaded into the receiver. Check the Topcon website for the latest updates.
- Check Topcon Technical Support (www.topconsupport.com) or myTopcon (<https://www.topconpositioning.com/support>) for the latest updates.

Then, try the following:

- Power cycle off/on the receiver by pressing the Power button or by using TRU (**Tools ▶ Reset receiver**).
- Restore default settings by pressing the Power button for 10 to 15 seconds or using TRU (**Tools ▶ Clear NVRAM**). This restores the receiver's parameters to the factory default settings and erases the almanac and ephemeris files. This action does not delete data files from the receiver memory.

If the problem persists, see the following sections for other solutions.

Powering Problems

The following are some of the most commonly encountered power problems.

The receiver does not power up

- An external power source may be improperly connected.
 - Make sure the power source is correctly connected.
 - Make sure the power source contacts are clean and dust free.
- The power source may be discharged (if a battery is used) or may not provide enough power.

Connect/attach a fully charged battery or a correct power supply and retry. See "Powering the Receiver" on page 13.

- If you are using an external power source, the cable may be disconnected or damaged.

Make sure the cable is securely connected and undamaged.

- The receiver may have a defective power source

Make sure the external power source is working properly.

Receiver Problems

The following are some of the most commonly encountered receiver problems.

The receiver cannot establish a connection to a computer or external controller

Cable specific problems:

- The cable is not properly plugged in.
 - Unplug the cable, then securely and properly reconnect it to the receiver.
- The cable is damaged.
 - Use an undamaged cable. Contact a dealer to replace the cable.
- The USB driver is not installed.
 - If you are using a USB cable connection, make sure the USB driver, included on the Software CD, is installed on the computer. You can also download the driver from the Topcon support Website at www.topconcare.com.

Generic problems:

- The receiver port used for connection is not in Command mode.
 - a. Connect the receiver to a computer and open TRU (see the *Topcon Receiver Utility (TRU) Online Help*).
 - b. Click **Receiver Settings** ▶ **Ports**.
 - c. Change the **Input** Mode for the port used for connection to **cmd**.
- You can also use the Vanguard web interface to place the unit in Command mode.

The receiver does not lock on to satellites for a long period of time

- The corresponding receiver options may be disabled or expired (L1/L2, GPS/GLONASS must be on to track satellites).
 - Order a new OAF with the desired options activated to enable or extend validity of the corresponding receiver options. Contact a dealer or visit the Topcon website for details.
 - Refer to the *Topcon Receiver Utility (TRU) Online Help* for a detailed description of options.

The receiver tracks too few satellites

- The survey is conducted near obstructions (tree canopy, tall buildings, and so forth).
 - Make sure the Multipath Reduction boxes have been enabled.
 - a. Connect the receiver to a computer and open TRU (see the *Topcon Receiver Utility (TRU) Online Help*).
 - b. In TRU, connect to the receiver.
 - c. On the TRU main window, choose **Receiver Settings** ▶ **Tracking** ▶ **Adv** tab. Make sure the **C/A code multipath reduction** check box is selected.
- Move to an area free of obstructions, if applicable.

The receiver cannot obtain Code Differential and/or RTK solutions

- Incorrect Base coordinates entered.
 - Specify the correct coordinates for the Base station using TRU or another suitable field data collection software.
- The receiver is not configured as a Base or Rover.
- The corresponding receiver options may be disabled or expired.
 - Order a new OAF with the required options activated to enable or extend validity of the corresponding receiver options.
 - Refer to the *Topcon Receiver Utility (TRU) Online Help* for a detailed description of options.
- There are not enough common satellites. In order to obtain a fixed solution, the Base and Rover should track at least five common satellites.
 - Check the elevation masks of the Rover and Base receivers; they should be the same. To do this, on the TRU main window, choose **Receiver Settings ▶ Tracking ▶ Obs.**
 - Verify there is a clear view of the sky to allow sufficient satellite tracking.
- A discrepancy exists between the differential standards used at the Base and Rover receivers.
 - Ensure the Base and Rover receivers use the same corrections input/output format:
 - a. Connect the receiver to a computer and open TRU (see the *Topcon Receiver Utility (TRU) Online Help*).
 - b. In TRU, connect to the receiver.
 - c. On the TRU main window, choose **Receiver Settings ▶ Ports.**
 - d. Double-click on the port to be configured and make sure the input mode of the Rover matches the format of the Base output mode (i.e. RTCM3).
- Poor satellite geometry (PDOP/GDOP values are too high).
 - Conduct the survey where satellite visibility is better (low PDOP value).
 - Ensure the elevation mask is less than 15 degrees.
- The elevation mask is above 15 degrees.
 - Lower the elevation mask. To do this, on the TRU main window, choose **Receiver Settings ▶ Tracking ▶ Obs.**
 - Verify there is a clear view of the sky to allow sufficient satellite tracking.
- There may be a source of radio interference that disrupts radio communications.
 - Change the RF channel (if possible).
 - Removing the source of the jamming signal or relocate the radio antennas (if possible).

The receiver does not start logging data

- The receiver does not have a memory card installed or the memory option is disabled or expired.
 - Make sure the memory option is enabled. For details, see the *Topcon Receiver Utility (TRU) Online Help*.
- The memory card does not have free space.
 - Download and/or delete data files to free up space for new files. See “Downloading and Deleting Files” on page 36.

Bluetooth Problems

The following are some of the most commonly encountered error messages and other problems.

TRU error message: Can't find receiver

- The receiver is turned off.
 - Ensure the receiver has power and is turned on.
- Bluetooth is not turned on; the BT LED is off.
 - Reset the receiver to the factory default settings by pressing the Power button for 10 to 15 seconds.
- There is interference.
 - Move the receiver, controller, or computer to an unobstructed location.
- The receiver is too far away.
 - Move the devices closer together.
- The receiver is already connected via Bluetooth to another device.
 - Disconnect the receiver from the other controller or computer.

TRU error message: Open COM# port failed: Access is denied

- Another application uses the computer port dedicated for connection.
 - Close the application, and then re-connect.
 - Connect the receiver via another, unused computer port.

After searching for available devices, none are discovered

- The receiver is not receiving power.
 - Check that the receiver is getting power and is turned on.
 - Check that the power cable is correctly attached to the port.
 - Unplug the cable, then securely and properly reconnect it to the receiver.
 - If the power cable is damaged, contact a Dealer to purchase a new cable.

Can see the icon for the receiver's Bluetooth module on the computer screen, but cannot connect to it

- Device security settings probably differ.
 - Make sure the Bluetooth enabled devices use the same security settings.
- Bluetooth module settings may have changed.
 - a. If the settings are changed for the Bluetooth module, remove it from the list of discovered Bluetooth devices using the Bluetooth manager program (supplied with the device used to manage the receiver).
 - b. Repeat the search.

Cellular Problems

The receiver's integrated cellular modem does not send and receive data

- Make sure the cellular antenna is properly connected to the receiver's ANT port.
- Make sure you are within your cellular coverage with minimal obstructions. You may want to check the strength of the cellular signals in your area using TRU. See the *TRU Online Help* embedded in the software.

TRU Problems

The following is the most commonly encountered TRU problem.

TRU cannot connect to the receiver

- The receiver is turned off.
 - Ensure the receiver has power and is turned on.
- If using a cable, the cable's connectors are improperly attached.
 - Check that the cable connector is attached to the correct serial port.
 - Unplug the cable, then securely and properly reconnect it to the receiver.
- If using a cable, the cable is damaged.
 - Use an undamaged cable.
 - Contact a dealer to purchase a new cable.
- If using Bluetooth wireless technology, the incorrect port is selected.
 - Use a computer or receiver that has Bluetooth wireless technology enabled/installed.
 - Make sure the computer and receiver use the correct ports for communication.

Cleaning and Storing the Receiver

- Use a clean cloth moistened with neutral detergent or water.
- Never use an abrasive cleaner, ether, thinner benzene, or other solvents.
- Always make sure the receiver is completely dry before storing it. Dry any moisture with a soft, clean cloth.

Getting Customer Support

If the troubleshooting hints and tips in this operator's manual fail to remedy the problem, contact Topcon Customer Representative. For contact information, see "Getting Technical Support" on page 3.

This chapter provides specifications for the receiver and its internal components.

General Details

Table 7 lists the receiver's general specifications.

Table 7. General Receiver Specifications

Physical	
Enclosure	Aluminum, IP67 rated extrusion
Color	Topcon Yellow and Topcon Grey
Dimensions (mm)	W: 150 mm x H: 60 mm x D: 200 mm
Weight (g)	< 2.0 kg (with internal batteries)
Antenna	External N connector
Status display/panel	MINTER (8 LEDs + power button + function button)
Serial/External Power	Hirose H205-Series (6-pin, multiplex) <ul style="list-style-type: none"> • Serial Ports A and B – RS-232 • Serial Port C – RS-422 • 2x Power – ODU 5 • Ethernet – RJ45 • USB Host – USB Type-A • USB Device – Mini-B
USB	USB Mini B 2.0 (client)
External antenna connector	N-Type connector
Bluetooth antenna	Fully integrated, high sensitivity
Tracking	
Number of Channels	452 channels Vanguard™ ASIC with patented Universal Tracking Channel Technology ^a
Tracked Signals	GPS: L1 C/A, L1C, L1P(Y), L2P(Y), L2C, L5 GLONASS: L1 C/A, L1P, L2 C/A, L2P, L3C GALILEO: GIOVE-A/B, E1b, Galileo E1, E5a, E5b, E6, AltBOC BDS: B1, B2, B3 with ICD availability QZSS: L1 C/A, L1C, L2C, L5, LEX L-Band: 1525-1560 MHz (OmniSTAR and TerraStar) SBAS: WAAS/EGNOS/MSAS
Multipath reduction	Yes, code and carrier
PLL/DLL setting	Adjustable bandwidth and order
Smoothing interval	Adjustable, code and carrier

Table 7. General Receiver Specifications

Data Output	
RTK Corrections	TPS, RTCM SC104 v 2.x, 3.x; CMR/CMR+ ^b
ASCII Output	NMEA 0183 version 2.x and 3.x
Measurement data rate (max.)	20 Hz standard - Up to 100 Hz optional ^c
Data and Memory	
Removable media	SD card
Internal memory	8 GB standard - Up to 32 GB
Message storage rate (max.)	20 Hz standard - up to 100 Hz optional
Environment	
Operating temperature	-20°C to +61°C (batteries) -40°C to +80°C (w/ external power on PW2/charging disabled on PWR1) -20°C to +50°C (w/ external power on PW1/battery charging)
Storage temperature	-40°C to +70°C
Humidity	100%, condensing
Waterproof rating	IPX7 (1 meter submersion)
Dust rating	IP6X (Fully dust proof)
Random vibration	MIL-STD 810G, Method 514.6, Broad band noise (random vibration), along each of 3 axes, Category 4, table 514.6C-IV
Shock	MIL-STD 810G, Method 516.5. Table 516.5-I Alternate Test Method of Classic Pulse; 40g, 11ms duration.
Technology	
	Topcon Vanguard™ ASIC technology Fence Antenna™ Technology Topcon advanced Multipath Rejection (AMR) Integrity Monitoring (RAIM) Topcon Automatic File Rotation Mode (AFRM) Universal Tracking Channels
Power	
Internal Batteries	2S x 4P, 7.2v, 1200 mAh
Battery charging time	<5 hours
Battery charging method	Connect the AC adaptor to charge the internal batteries. Available run charge when connected to an external battery. Charging of internal batteries when power input is greater than 10 V.
External power input	9 to 28 VDC (operating) ^d 28 to 80 VDC (over voltage protection)
External power supply adapter rating	Input: 100-240 VAC, 50-60 Hz, 0.8A Output: +12VDC/2.5A (5A preferred)

Table 7. General Receiver Specifications

Communication	
Serial	ODU-7: RS232, RX/TX, RTS/CTS DB-9: RS232, RX/TX, RTS/CTS, RS232/RS422, RX/TX, RTS/CTS
USB	2 ports; USB Mini-B 2.0 (device) and USB Type-A (host)
Wi-Fi	802.11b Client/AP 802.11 g/802.11 n (20 MHz)
Bluetooth	v2.1 + EDR
Cellular ^e	Yes. GSM/GPRS/EDGE/UMTS/3G/ enabled
Ethernet	RJ45
Survey Accuracy^f	
Static (post-processed)	H: 3 mm + 0.1 ppm (x baseline distance) V: 3.5 mm + 0.4 ppm (x baseline distance)
Kinematic, RTK	L1 +L2: H: 8 mm + 1 ppm V: 15 mm + 1 ppm
DGPS	H: 0.4 m V: 0.6 m
SBAS	H: 1.0 m V: 1.5 m
Cold start Warm start Reacquisition	<40 sec. <20 sec. <1 sec.
RTK Time-to-First-Fix (TTFF)	<20 sec.

- a. Vanguard ASIC includes two dedicated channels for L-Band signal tracking. The Net-G5 receiver does not support L-Band signal tracking.
- b. CMR/CMR+ is a third-party proprietary format. Use of this format is not recommended and performance cannot be guaranteed. Use of industry standard RTCM 3.x is always recommended for optimal performance.
- c. 100 Hz operation can be supported for custom applications. For more information, contact your dealer.
- d. 9 to 28 VDC is the operating range of the external power source when the receiver is on. To turn the receiver on, the power input must be between 8 to 30 VDC. To charge the internal batteries, the external power input must be greater than 12 VDC.
- e. Cellular modem functionality will be added in a later version of firmware.
- f. Accuracy will vary depending on the number of satellites used, obstructions, satellite geometry (PDOP), occupation time, multipath effects, and atmospheric conditions. Performance may be degraded in conditions with high Ionospheric activity, extreme multipath, or under dense foliage. For maximum system accuracy, always follow best practices for GNSS data collections.

General Warnings



To comply with RF exposure requirements, maintain at least 25cm between the user and the receiver when operating LongLINK technology.



TPS receivers are designed for survey and survey related uses (that is, surveying coordinates, distances, angles and depths, and recording such measurements). This product should never be used:

- Without the user thoroughly understanding this manual.
- After disabling safety systems or altering the product.
- With unauthorized accessories.
- Without proper safeguards at the survey site.
- Contrary to applicable laws, rules, and regulations.

Receiver Warnings



Tampering with the receiver by the end users or non-factory authorized technicians will void the receiver's warranty:

- Do not attempt to open the receiver and modify any of its internal components.
- Do not charge in conditions different than specified.
- Do not short circuit.

Usage Warnings



If this product has been dropped, altered, transported or shipped without proper packaging, or otherwise treated without care, erroneous measurements may occur. The owner should periodically test this product to ensure it provides accurate measurements. Inform TPS immediately if this product does not function properly.



Only allow authorized Topcon warranty service centers to service or repair this product.

The following sections provide information on this product's compliance with government regulations for use.

FCC Compliance

This equipment complies with FCC radiation exposure limits set forth for uncontrolled equipment and meets the FCC radio frequency (RF) Exposure Guidelines in Supplement C to OET65. This equipment has very low levels of RF energy that it deemed to comply without maximum permissive exposure evaluation (MPE). But it is desirable that it should be installed and operated with at least 20cm and more between the radiator and person's body (excluding extremities: hands, wrists, feet and ankles).

This equipment has been tested and found to comply with the limits for a Class A digital device pursuant to part 15 of the FCC rules. These limits are designed to provide reasonable protection against harmful interference when the equipment is operated in a commercial environment. This equipment generates, uses, and can radiate radio frequency energy and, if not installed and used in accordance with the instruction manual, may cause harmful interference to radio communications. Operation of this equipment in a residential area is likely to cause harmful interference in which case the user will be required to correct the interference at his own expense.

If this equipment does cause interference to radio or television equipment reception, which can be determined by turning the equipment off and on, the user is encouraged to try to correct the interference by one or more of the following measures:

- Reorient or relocate the receiving antenna.
- Move the equipment away from the receiver.
- Plug the equipment into an outlet on a circuit different from that to which the receiver is powered.
- Consult the dealer or an experienced radio/television technician for additional suggestions.



Any changes or modifications to the equipment not expressly approved by the party responsible for compliance could void your authority to operate such equipment.

Industry Canada Compliance

This device complies with Industry Canada licence-exempt RSS standard(s). Operation is subject to the following two conditions: (1) this device may not cause interference, and (2) this device must accept any interference, including interference that may cause undesired operation of the device.

Le présent appareil est conforme aux CNR d'Industrie Canada applicables aux appareils radio exempts de licence. L'exploitation est autorisée aux deux conditions suivantes : (1) l'appareil ne doit pas produire de brouillage, et (2) l'utilisateur de l'appareil doit accepter tout brouillage radioélectrique subi, même si le brouillage est susceptible d'en compromettre le fonctionnement.

CAN ICES-3 (A)/NMB-3 (A)

Community of Europe Compliance

The product described in this manual is in compliance with the R&TTE and EMC directives from the European Community.

European Community Declaration of Conformity with R&TTE Directive 1999/5/EC

The following standards were applied: (R&TTE Directive 1999/5/EEC)

- ETSI EN 301 489-1 V1.9.2 (2011-09)
- ETSI EN 301 489-3 V1.6.1 (2013-08)
- ETSI EN 301 489-7 V1.3.1 (2005-11)
- ETSI EN 301 489-17 V2.2.1 (2012-09)
- ETSI EN 301 489-24 V1.5.1 (2010-10)
- ETSI EN 301 908-1 V6.2.1 (2013-04)
- ETSI EN 301 908-2 V6.2.1 (2013-04)
- ETSI EN 300 328 V1.8.1 (2012-06)
- ETSI EN 301 511 V9.0.2 (2003-03)
- ETSI EN 300 400-2 V1.4.1 (2010-08)
- EN 55022:2010/AC:2011
- EN 55024L2010
- EN: 62311:2008
- EN 60950-1:2006+A1:2010+AC:2011+A2:2013

The following CE mark is affixed to the device:



This is a Class A product. In a domestic environment this product may cause radio interference in which case the user may be required to take adequate measures.

Declaration of Conformity (R&TTE Directive 1999/5/EC)

esky [Czech]	(<i>Topcon</i>) tímto prohlašuje, že tento (<i>Net-G5</i>) je ve shod se základními požadavky a dalšími příslušnými ustanoveními směrnice 1999/5/ES.
Dansk [Danish]	Undertegnede (<i>Topcon</i>) erklærer herved, at følgende udstyr (<i>Net-G5</i>) overholder de væsentlige krav og øvrige relevante krav i direktiv 1999/5/EF.
Deutsch [German]	Hiermit erklärt (<i>Topcon</i>) dass sich das Gerät (<i>Net-G5</i>) in Übereinstimmung mit den grundlegenden Anforderungen und den übrigen einschlägigen Bestimmungen der Richtlinie 1999/5/EG befindet.
Eesti [Estonian]	Käesolevaga kinnitab (<i>Topcon</i>) seadme (<i>Net-G5</i>) vastavust direktiivi 1999/5/EÜ põhinõuetele ja nimetatud direktiivist tulenevatele teistele asjakohastele sätetele.
English	Hereby, (<i>Topcon</i>) declares that this (<i>Net-G5</i>) is in compliance with the essential requirements and other relevant provisions of Directive 1999/5/EC.
Español [Spanish]	Por medio de la presente (<i>Topcon</i>) declara que el (<i>Net-G5</i>) cumple con los requisitos esenciales y cualesquiera otras disposiciones aplicables o exigibles de la Directiva 1999/5/CE.

[Greek]	ΜΕ ΤΗΝ ΠΑΡΟΥΣΑ (<i>Topcon Positioning Systems, Inc.</i>) ΔΗΛΩΝΕΙ ΟΤΙ (<i>Net-G5</i>) ΣΥΜΜΟΡΦΟΝΕΤΑΙ ΠΡΟΣ ΤΙΣ ΟΥΣΙΩΔΕΙΣ ΑΠΑΙΤΗΣΕΙΣ ΚΑΙ ΤΙΣ ΛΟΙΠΕΣ ΣΧΕΤΙΚΕΣ ΔΙΑΤΑΞΕΙΣ ΤΗΣ ΟΔΗΓΙΑΣ 1999/5/ΕΚ.
Français [French]	Par la présente (<i>Topcon</i>) déclare que l'appareil (<i>Net-G5</i>) est conforme aux exigences essentielles et aux autres dispositions pertinentes de la directive 1999/5/CE.
Italiano [Italian]	Con la presente (<i>Topcon</i>) dichiara che questo (<i>Net-G5</i>) è conforme ai requisiti essenziali ed alle altre disposizioni pertinenti stabilite dalla direttiva 1999/5/CE.
Latviski [Latvian]	Ar šo (<i>Topcon</i>) deklar, ka (<i>Net-G5</i>) atbilst Direktvas 1999/5/EK btiskajm prasbm un citiem ar to saisttjiem noteikumiem.
Lietuvi [Lithuanian]	Šiuo (<i>Topcon</i>) deklaruoja, kad šis (<i>Net-G5</i>) atitinka esminius reikalavimus ir kitas 1999/5/EB Direktyvos nuostatas.
Nederlands [Dutch]	Hierbij verklaart (<i>Topcon</i>) dat het toestel (<i>Net-G5</i>) in overeenstemming is met de essentiële eisen en de andere relevante bepalingen van richtlijn 1999/5/EG.
Malti [Maltese]	Hawnhekk, (<i>Topcon</i>) , jiddikjara li dan (<i>Net-G5</i>) jikkonforma mal-tiijiet essenzjali u ma provvedimenti orajn rilevanti li hemm fid-Dirrettiva 1999/5/EC.
Magyar [Hungarian]	Alulírott, (<i>Topcon</i>) nyilatkozom, hogy a (<i>Net-G5</i>) megfelel a vonatkozó alapvető követelményeknek és az 1999/5/EC irányelv egyéb előírásainak.
Polski [Polish]	Niniejszym, (<i>Topcon</i>) , deklaruje, e (<i>Net-G5</i>) spenia wymagania zasadnicze oraz stosowne postanowienia zawarte Dyrektywie 1999/5/EC.
Português [Portugues]	(<i>Topcon</i>) declara que este (<i>Net-G5</i>) está conforme com os requisitos essenciais e outras disposições da Directiva 1999/5/CE.
Slovensko [Slovenian]	(<i>Topcon</i>) izjavlja, da je ta (<i>Net-G5</i>) v skladu z bistvenimi zahtevami in ostalimi relevantnimi določili direktive 1999/5/ES.
Slovensky [Slovak]	(<i>Topcon</i>) týmto vyhlasuje, že (<i>Net-G5</i>) spa základné požiadavky a všetky príslušné ustanovenia Smernice 1999/5/ES.
Suomi [Finnish]	(<i>Topcon</i>) vakuuttaa täten että (<i>Net-G5</i>) tyyppinen laite on direktiivin 1999/5/EY oleellisten vaatimusten ja sitä koskevien direktiivin muiden ehtojen mukainen.
Svenska [Swedish]	Härmed intygar (<i>Topcon</i>) att denna (<i>Net-G5</i>) står i överensstämmelse med de väsentliga egenskapskrav och övriga relevanta bestämmelser som framgår av direktiv 1999/5/EG.

WEEE Directive

Following information is for EU-member states only:

The use of the symbol below indicates that this product may not be treated as household waste. By ensuring this product is disposed of correctly, to help prevent potential negative consequences for the environment and human health, which could otherwise be caused by inappropriate waste handling of this product. For more detailed information about the take-back and recycling of this product, please contact a supplier where you purchased the product or consult.



Bluetooth Transmission Statements/Compliance

This Bluetooth device is compliant to the following profiles of the core spec version 2.1/2.1+EDR:

- Baseband
- HCI
- Link Manager
- Radio

The radio has been tested using the maximum antenna gain of 2.3 dBi and the Bluetooth qualification is valid for any antenna with the same or less gain.

Korean KC-RF Compliance

해당 무선설비는 전파혼신 가능성이 있으므로 인명안전과 관련된 서비스는 할 수 없습니다 .

무선사양 (Wireless specification): Bluetooth 2.1 + EDR, Wi-Fi 802.11 b/g/n

사용주파수 (Used Frequency): Bluetooth 2402-2480 MHz / Wi-Fi 2412-2472 MHz

채널 수 (the number of channels): Bluetooth: 79 / Wi-Fi: 13

공중선전력 (Antenna Power): 2.1 dBi

변조방식 (Type of the modulation): Bluetooth - GFSK, 8PSK / Wi-Fi - CCK, OFDM

인증정보 (Product Id Code): MSIP-RMM-T8S-130400

신청자 (Applicant): Topcon Positioning Systems, Inc.

기기명칭 (Type of equipment): GNSS receiver device with Bluetooth radio

모델 이름 (Model Name): Net-G5

제조연월 (Year of manufacture): 2014

제조사 및 제조국가 (Manufacturer and country of origin): Topcon, USA

인증자 식별 부호 (Applicant Code): T8S

Korean KC-EMC Class A Statement

이 기기는 업무용 (A 급) 전자파 적합기기로서 판매자 또는 사용자는 이 점을 주의하시기 바라며, 가정외의 지역에서 사용하는 것을 목적으로 합니다 .

Korean KC-Cellular Modem Compliance

This optional integrated cellular modem (PHS8-K) reference application complies with the requirements of the Korean Communications Commission (KCC). The certificate granted in accordance with KCC has the identifier: KCC-CRM-QIP-PHS8K.

Japan Radio Law and Telecommunications Business Law Compliance

Bluetooth and Wi-Fi Module Compliance

The integrated Bluetooth and Wi-Fi module TiWi-BLE reference application described on page 72 (General Details - Communication) complies in accordance with the provisions of Article 38-24 paragraph 1 of Japan Radio Law. The certificate granted in accordance with Japan Radio Law has the following:

Identifier:   211-150204

Cellular Module Compliance

The optional integrated cellular modem (PHS8-J) reference application complies with the requirements of the Japanese Telecommunications Business Law and Ordinance Concerning Conformity Certification of Specified Radio as well as with the requirements of the Japanese "Radio Law" and "Ordinance Concerning Technical Conditions Compliance Approval and Certification Type for terminal Equipment."

The certificate granted in accordance with the Telecommunications Business Law has the identifier: AD 12-0011 202.

The certificate granted in accordance with the "Radio Law" has the identifier: 202-SMA014.

B

BDS – BeiDou Navigation Satellite System maintained and operated by China. See also, BeiDou.

Base Station – A GNSS receiver set up over a known point, which is used to derive correction information for nearby Rover (mobile) GNSS receivers.

BeiDou – Navigation Satellite System maintained and operated by China. See also, BDS.

Bluetooth® – Often used in place of cables, Bluetooth is open wireless technology for exchanging data over short distances from fixed and mobile devices.

C

G

GALILEO – The satellite system currently being maintained and operated by the European Union (EU) and European Space Agency (ESA).

GGD – GPS + GLONASS Dual Frequency signal tracking.

GLONASS – The Global Navigation Satellite System maintained and operated by the Russian Federation.

GNSS – Global Navigation Satellite Systems, such as GPS and GLONASS.

GPS – The Global Positioning System maintained and operated by the United States Department of Defense.

L

L1 – The primary L-band carrier used by GPS and GLONASS satellites to transmit satellite data.

L2 – The secondary L-band carrier used by GPS and GLONASS satellites to transmit satellite data.

Light-Emitting Diode (LED) – Used as indicator lights on the receiver to display the status of the receiver's components and control receiver operations.

M

MAGNET Field™ – Data controller software that is part of the MAGNET software system.

MAGNET Office™ – Post-processing and CAD solution software for surveying and grade application. It is part of the MAGNET software system.

MINTER – The receiver's Minimum Interface used to display and control data input and output.

N

Network RTK – Collects satellite observations from the reference stations within the network and sends RTK corrections to the Rover.

O

Option Authorization File (OAF) – This enables the specific features that a customer purchases.

P

Phase Center of Antenna – The point from which the electromagnetic radiation spreads spherically outward, with the phase of the signal being equal at any point on the sphere.

Pocket-3D – Field controller software by Topcon that supports both GNSS and TS.

R

Real-Time Kinematic (RTK) – A precise method of real-time surveying. RTK enables you to check the measurement quality without having to process the data.

Root Mean Square (RMS) – Statistical measure of the magnitude of a varying quantity.

Rover – A mobile GNSS receiver and data collector used for determining location in the field.

S

Satellite-Based Augmentation Systems (SBAS) – Complements existing global navigation systems. SBAS transmits differential corrections and messages for navigation satellites that are within sight of a network or reference stations in a wide area, such as a continent.

Static Survey – Typically uses a network or multiple baseline approach for positioning. This method provides the highest accuracy and requires the longest observation times.

T

Topcon Receiver Utility (TRU) – Hardware configuration software for receivers and peripheral devices. TRU is available from the myTopcon Website (<https://www.topconpositioning.com/support>).

U

Universal Serial Bus (USB) – A connection standard used by devices, such as a receiver, controller, computer, etc.



www.topconpositioning.com