

GRS-1



Operator's Manual



GRS-1 Operator's Manual

Part Number 7010-0926

Rev A

©Copyright Topcon Positioning Systems, Inc.

April, 2009

All contents in this manual are copyrighted by Topcon. All rights reserved. The information contained herein may not be used, accessed, copied, stored, displayed, sold, modified, published, or distributed, or otherwise reproduced without express written consent from Topcon.

Topcon only sells GPS products into Precision Markets.
Please go to www.topcongps.com for detailed market information.

Table of Contents

Chapter 1

Introduction	1-1
Principles of Operation	1-2
GNSS Overview	1-3
Calculating Absolute Positions	1-4
Calculating Differential Positions	1-5
Essential Components for Quality Surveying	1-6
Conclusion	1-7
GRS-1 Overview	1-7
Getting Acquainted with the GRS-1	1-8
Rechargeable and Backup Batteries	1-9
GRS-1 Front	1-10
GRS-1 Back	1-13
GRS-1 Ports	1-14
SD Card Slot	1-14
Integrated Camera	1-15
External GPS Antenna Connector	1-16
System Cables	1-17
GRS-1 Software	1-17
Optional Accessories	1-18
Option Authorization File (OAF)	1-22
Handling Precautions	1-22
Storing the GRS-1	1-23

Chapter 2

Preparing the GRS-1 for Use	2-1
Attaching the Hand Strap	2-1
Powering the GRS-1	2-2
Installing the Battery	2-2
Charging the Battery	2-3
Charging and Battery Storage Notes	2-5
Replacing the Backup Battery	2-6

Starting the GRS-1 2-7
 Calibrating the Touch Screen 2-7
 Setting the Power Management 2-9
 Installing Software 2-9
 Installing an Optional SD Card 2-10

Chapter 3

Using the GRS-1 3-1

Connecting the GRS-1 with Other Devices 3-1
 Connecting the GRS-1 and a Computer 3-2
 About ActiveSync and Windows Mobile
 Device Center 3-3
 Connecting the GRS-1 and a Bluetooth Device 3-4
 Surveying with the GRS-1 Using
 Topcon Receiver Utility (TRU) 3-6
 Surveying with the GRS-1 3-6
 Surveying with the GRS-1 and an External Antenna 3-7
 Surveying with the GRS-1 and a Beacon Receiver ... 3-8
 Surveying with the GRS-1 and an External
 GPS Receiver 3-9

Chapter 4

Using the GNSS Compass, Camera 4-1

Topcon Receiver Utility 4-1
 Using the Compass 4-3
 Calibrating the Compass 4-5
 Recalibrating the Compass 4-8
 Viewing GNSS Information and Settings 4-8
 Using the Camera 4-8

Chapter 5

Using the Bluetooth Manager 5-1

Getting Started 5-1
 Getting Acquainted 5-2
 Working with Bluetooth Manager 5-5
 Discovering Devices 5-6
 Adding to the List of Favorite Devices 5-8
 Viewing Device Properties 5-10

Deleting a Device from the List	5-11
Setting Device Preferences	5-11
Pairing Bluetooth Devices	5-13

Chapter 6

TPS Connection Manager	6-1
Main Menu	6-2
Create New Connection	6-3
Cellular Power On	6-4
Data Connection	6-4
GPS Receiver Power	6-7
About the Tool	6-8

Chapter 7

Troubleshooting	7-1
Check This First!	7-1
Troubleshooting Quick List	7-2
Resetting the Software	7-3
Restoring Bluetooth Module Defaults	7-4
Resetting the Hardware	7-4
Format Reset	7-5
Charging/Powering Problems	7-6
GRS-1 Problems	7-7
Bluetooth Problems	7-8
Obtaining Technical Support	7-10
Phone	7-10
E-mail	7-11
Website	7-12

Chapter 8

Updating the Operating System	8-1
Required Equipment	8-1
OS Installation File	8-2
Format Reset	8-2
Installing the OS	8-4
Troubleshooting	8-5
Installing Applications	8-5

Appendix A

Specifications A-1

- GRS-1 Specifications A-2
 - General Details A-2
 - GPS Details A-6
 - Bluetooth Details A-7
- Connector Specifications A-8
 - Serial Connector A-8
 - USB Connector A-9

Appendix B

Safety Warnings B-1

- General Warnings B-1
- Battery Pack Warnings B-2
- Usage Warnings B-3

Appendix C

Regulatory Information C-1

- FCC Compliance C-1
 - Federal Communication Commission
 - Declaration of Conformity (DoC) Statement ... C-2
 - Industry Canada (IC) Regulatory Information C-2
 - FCC/IC RF Radiation Exposure Statement For
 - Bluetooth and 802.11b/g C-3
 - European Community Declaration of
 - Conformity with R&TTE Directive 1999/5/EC C-4
- Canadian Emission Labeling Requirements C-4
 - Declaration of Conformity with Regard to the
 - R&TTE Directive 1999/5/EC C-5
- Community of Europe Compliance C-8

Appendix D

Warranty Terms D-1

Preface

Thank you for purchasing this Topcon product. The materials available in this Manual (the “Manual”) have been prepared by Topcon Positioning Systems, Inc. (“TPS”) for owners of Topcon products, and are designed to assist owners with the use of the receiver and its use is subject to these terms and conditions (the “Terms and Conditions”).



Please read these Terms and Conditions carefully.

Terms and Conditions

USE This product is designed to be used by a professional. The user should have a good knowledge of the safe use of the product and implement the types of safety procedures recommended by the local government protection agency for both private use and commercial job sites.

COPYRIGHT All information contained in this Manual is the intellectual property of, and copyrighted material of TPS. All rights are reserved. You may not use, access, copy, store, display, create derivative works of, sell, modify, publish, distribute, or allow any third party access to, any graphics, content, information or data in this Manual without TPS’ express written consent and may only use such information for the care and operation of your receiver. The information and data in this Manual are a valuable asset of TPS and are developed by the expenditure of considerable work, time and money, and are the result of original selection, coordination and arrangement by TPS.

TRADEMARKS GRS-1, MG-A8, PG-A1, PG-A5, RH-1, BH-1, BR-1, Topcon Receiver Utility (TRU), TopSURV, TopGIS, Field Tools for ArcPad, Pocket-3D, Pocket Layout, Topcon and Topcon Positioning Systems are trademarks or registered trademarks of TPS. Microsoft, Windows Mobile, and the Windows logo are either trademarks or registered trademarks of Microsoft Corporation in the United States and/or other countries. The Bluetooth® word mark and logos are owned by Bluetooth SIG, Inc. and any use of such marks by Topcon Positioning Systems, Inc. is used under license. Other product and company names mentioned herein may be trademarks of their respective owners.

DISCLAIMER OF WARRANTY EXCEPT FOR ANY WARRANTIES IN AN APPENDIX OR A WARRANTY CARD ACCOMPANYING THE PRODUCT, THIS MANUAL AND THE RECEIVER ARE PROVIDED “AS-IS.” THERE ARE NO OTHER WARRANTIES. TPS DISCLAIMS ANY IMPLIED WARRANTY OF MERCHANTABILITY OR FITNESS FOR ANY PARTICULAR USE OR PURPOSE. TPS AND ITS DISTRIBUTORS SHALL NOT BE LIABLE FOR TECHNICAL OR EDITORIAL ERRORS OR OMISSIONS CONTAINED HEREIN; NOR FOR INCIDENTAL OR CONSEQUENTIAL DAMAGES RESULTING FROM THE FURNISHING, PERFORMANCE OR USE OF THIS MATERIAL OR THE RECEIVER. SUCH DISCLAIMED DAMAGES INCLUDE BUT ARE NOT LIMITED TO LOSS OF TIME, LOSS OR DESTRUCTION OF DATA, LOSS OF PROFIT, SAVINGS OR REVENUE, OR LOSS OF THE PRODUCT’S USE. IN ADDITION TPS IS NOT RESPONSIBLE OR LIABLE FOR DAMAGES OR COSTS INCURRED IN CONNECTION WITH OBTAINING SUBSTITUTE PRODUCTS OR SOFTWARE, CLAIMS BY OTHERS, INCONVENIENCE, OR ANY OTHER COSTS. IN ANY EVENT, TPS SHALL HAVE NO LIABILITY FOR DAMAGES OR OTHERWISE TO YOU OR ANY OTHER PERSON OR ENTITY IN EXCESS OF THE PURCHASE PRICE FOR THE RECEIVER.

LICENSE AGREEMENT Use of any computer programs or software supplied by TPS or downloaded from a TPS website (the “Software”) in connection with the receiver constitutes acceptance of these Terms

and Conditions in this Manual and an agreement to abide by these Terms and Conditions. The user is granted a personal, non-exclusive, non-transferable license to use such Software under the terms stated herein and in any case only with a single receiver or single computer. You may not assign or transfer the Software or this license without the express written consent of TPS. This license is effective until terminated. You may terminate the license at any time by destroying the Software and Manual. TPS may terminate the license if you fail to comply with any of the Terms or Conditions. You agree to destroy the Software and manual upon termination of your use of the receiver. All ownership, copyright and other intellectual property rights in and to the Software belong to TPS. If these license terms are not acceptable, return any unused software and manual.

CONFIDENTIALITY This Manual, its contents and the Software (collectively, the “Confidential Information”) are the confidential and proprietary information of TPS. You agree to treat TPS’ Confidential Information with a degree of care no less stringent than the degree of care you would use in safeguarding your own most valuable trade secrets. Nothing in this paragraph shall restrict you from disclosing Confidential Information to your employees as may be necessary or appropriate to operate or care for the receiver. Such employees must also keep the Confidentiality Information confidential. In the event you become legally compelled to disclose any of the Confidential Information, you shall give TPS immediate notice so that it may seek a protective order or other appropriate remedy.

WEBSITE; OTHER STATEMENTS No statement contained at the TPS website (or any other website) or in any other advertisements or TPS literature or made by an employee or independent contractor of TPS modifies these Terms and Conditions (including the Software license, warranty and limitation of liability).

SAFETY Improper use of the receiver can lead to injury to persons or property and/or malfunction of the product. The receiver should only be repaired by authorized TPS warranty service centers. Users should review and heed the safety warnings in an Appendix.

MISCELLANEOUS The above Terms and Conditions may be amended, modified, superseded, or canceled, at any time by TPS. The above Terms and Conditions will be governed by, and construed in accordance with, the laws of the State of California, without reference to conflict of laws.

Manual Conventions

This manual uses the following conventions:

Example	Description
File ▶ Exit	Click the File menu and click Exit .
<i>Connection</i>	Indicates the name of a dialog box or screen.
<i>Frequency</i>	Indicates a field on a dialog box or screen, or a tab within a dialog box or screen.
Enter	Press or click the button or key labeled Enter .



Further information to note about the configuration, maintenance, or setup of a system.



Supplementary information that can help you configure, maintain, or set up a system.



Supplementary information that can have an affect on system operation, system performance, measurements, or personal safety.



Notification that an action has the potential to adversely affect system operation, system performance, data integrity, or personal health.



Notification that an action *will* result in system damage, loss of data, loss of warranty, or personal injury.



Under no circumstances should this action be performed.

Introduction

The GRS-1 receiver is a dual-frequency, GPS+GLONASS L1, L2 receiver and hand-held controller built to be the most advanced, compact, and portable receiver for the GIS and surveying market. An integrated electronic compass and digital camera make the GRS-1 an all-purpose device that can also be utilized as a field collector.

The GRS-1 receiver is a multi-function, multi-purpose receiver intended for precision markets. Precision markets means markets for equipment, subsystems, components and software for surveying, construction, commercial mapping, civil engineering, precision agriculture and land-based construction and agriculture machine control, photogrammetry mapping, hydrographic and any use reasonably related to the foregoing.

The GRS-1 can received and process both L1 and L2 signals, improving the accuracy of your survey points and positions. The GPS+ component of GRS-1 receivers means you can access both the GPS (Global Positioning System) satellites of the United States, and the GLONASS (Global Navigation Satellite System) satellites of the Russian Federation, increasing the number of satellites your receiver can detect, thus improving the accuracy of your survey points, increasing productivity, and reducing cost.

The dual-frequency and GPS+ features of the GRS-1 combine to provide the only real time kinematic (RTK) system accurate for short and long baselines. Several other features, including multipath mitigation and co-op tracking, provide under-canopy and low signal strength reception. The GRS-1 provides the functionality, accuracy, availability, and integrity needed for fast and easy data collection.

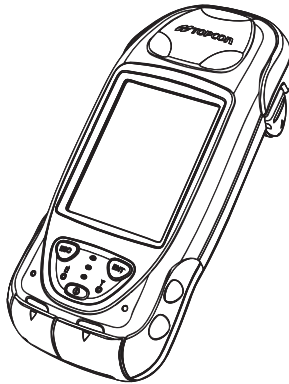

Figure 1-1. GRS-1

Principles of Operation

The GRS-1 is a fully integrated hand-held controller and GPS+ GLONASS L1, L2 receiver. An integrated electronic compass and digital camera make the GRS-1 an all-purpose, GIS field mapping unit.

The hand-held controller component of the GRS-1 includes the Windows® Mobile® operating system and color LCD touch screen. Integrated Bluetooth® and Wireless LAN technology allows this system to be a cable-free controller/receiver for maximum portability. The casing is durable and built for rugged use. As a field controller, the GRS-1 can run a full suite of field software for working with total stations and RTK GPS systems.

The GPS+ receiver component of the GRS-1 can receive and process GPS+GLONASS L1, L2 signals improving the accuracy of your survey points and positions. The GPS+ features of the receiver combine to provide a positioning system accurate for any survey. Several other features, including multipath mitigation, provide under-canopy and low signal strength reception. When power is turned on and the receiver self-test completes, the receiver's 72 channels initialize and begin tracking visible satellites. Each of the receiver's

channels can be used to track any one of the GPS or GLONASS signals. The number of channels available allows the receiver to track all visible GPS and Glonass satellites at any time and location.

An internal GPS+GLONASS L1 antenna equipped with a low noise amplifier (LNA) and the receiver's radio frequency (RF) device are connected with a coaxial cable. The wide-band signal received is down-converted, filtered, digitized, and assigned to different channels. The receiver processor controls the process of signal tracking.

Once the signal is locked in the channel, it is demodulated and necessary signal parameters (carrier and code phases) are measured. Also, broadcast navigation data are retrieved from the navigation frame.

GNSS Overview

Currently, the following three global navigation satellite systems (GNSS) offer line-of-site radio navigation and positioning, velocity, and time services on a global, all-weather, 24-hour scale to any user equipped with a GNSS tracking receiver on or near the Earth's surface:

- GPS – the Global Positioning System maintained and operated by the United States Department of Defense. For information on the status of this system, visit the US Naval Observatory website (<http://tycho.usno.navy.mil/>) or the US Coast Guard website (<http://www.navcen.uscg.gov/>).
- GLONASS – the Global Navigation Satellite System maintained and operated by the Russian Federation Ministry of Defense. For information on the status of this system, visit the Ministry of Defense website (http://www.glonass-center.ru/frame_e.html).
- GALILEO – an upcoming global positioning system maintained and operated by Galileo Industries, a joint venture of several European space agencies working closely with the European Space Agency. Unlike GPS and GLONASS, this is a civil endeavor and is currently in the development and validation

stage. For information on the status of this system, visit the Galileo Industries website (<http://www.galileo-industries.net>).

Despite numerous technical differences in the implementation of these systems, satellite positioning systems have three essential components:

- **Space** – GPS, GLONASS, and GALILEO satellites orbit approximately 12,000 nautical miles above Earth and are equipped with a clock and radio. These satellites broadcast digital information (ephemerides, almanacs, time&frequency corrections, etc.).
- **Control** – Ground stations located around the Earth that monitor the satellites and upload data, including clock corrections and new ephemerides (satellite positions as a function of time), to ensure the satellites transmit data properly.
- **User** – The community and military that use GNSS receivers and the corresponding satellites to calculate positions.

Calculating Absolute Positions

When calculating an absolute position, a stationary or moving receiver determines its three-dimensional position with respect to the origin of an Earth-Center Earth-Fixed coordinate system. To calculate this position, the receiver measures the distance (called pseudo-ranges) between it and at least four satellites. The measured pseudo-ranges are corrected for clock differences (receiver and satellites) and signal propagation delays due to atmospheric effects. The positions of the satellites are computed from the ephemeris data transmitted to the receiver in navigation messages. When using a single satellite system, the minimum number of satellites needed to compute a position is four. In a mixed satellite scenario (GPS, GLONASS, GALILEO), the receiver must lock onto at least five satellites to obtain an absolute position.

To provide fault tolerance using only GPS or only GLONASS, the receiver must lock onto a fifth satellite. Six satellites will provide fault tolerance in mixed scenarios.

Calculating Differential Positions

DGPS, or Differential GPS, typically uses the measurements from two or more remote receivers to calculate the difference (corrections) between measurements, thus providing more accurate position solutions.

With DGPS, one receiver is placed at a known, surveyed location and is referred to as the reference receiver or base station. Another receiver is placed at an unknown location and is referred to as the remote receiver or rover. The reference station collects the range measurements from each GPS satellite in view and forms the differences (corrections) between the calculated distance to the satellites and the measured pseudo-ranges to the satellites.

These corrections are then built up to the industry standard (RTCM or various proprietary standards) established for transmitting differential corrections and broadcast to the remote receiver(s) using a data communication link. The remote receiver applies the transmitted DGPS corrections to its range measurements of the same satellites.

Using this technique, the spatially correlated errors—such as satellite orbital errors, ionospheric errors, and tropospheric errors—can be significantly reduced, thus improving the position solution accuracy of the GPS.

A number of differential positioning implementations exist, including post-processing surveying, real-time kinematic surveying, maritime radio beacons, geostationary satellites (as with the OmniSTAR service), and the wide area augmentation system (WAAS) service.

The real-time kinematic (RTK) method is the most precise method of real-time surveying. RTK requires at least two receivers collecting navigation data and communication data link between the receivers. One of the receivers is usually at a known location (Base) and the other is at an unknown location (Rover). The Base receiver collects carrier phase measurements, generates RTK corrections, and sends this data to the Rover receiver. The Rover processes this transmitted data with its own carrier phase observations to compute its relative

position with high accuracy, achieving an RTK accuracy of up to 1 cm horizontal and 1.5 cm vertical.

Essential Components for Quality Surveying

Achieving quality position results requires the following elements:

- Accuracy – The accuracy of a position primarily depends upon the satellite geometry (Geometric Dilution of Precision, or GDOP) and the measurement (ranging) errors.
 - Differential positioning (DGPS and RTK) strongly mitigates atmospheric and orbital errors, and counteracts Selective Availability (SA) signals the US Department of Defense transmits with GPS signals.
 - The more satellites in view, the stronger the signal, the lower the DOP number, the higher positioning accuracy.
- Availability – The availability of satellites affects the calculation of valid positions. The more visible satellites available, the more valid and accurate the position. Natural and man-made objects can block, interrupt, and distort signals, lowering the number of available satellites and adversely affecting signal reception.
- Integrity – Fault tolerance allows a position to have greater integrity, increasing accuracy. Several factors combine to provide fault tolerance, including:
 - Receiver Autonomous Integrity Monitoring (RAIM) detects faulty GPS and GLONASS satellites and removes them from the position calculation.
 - Five or more visible satellites for only GPS or only GLONASS; six or more satellites for mixed scenarios.
 - Wide Area Augmentation Systems (WAAS, EGNOS, etc.) creates and transmit, along with DGPS corrections, data integrity information (for example, satellite health warnings).
 - Current ephemerides and almanacs.

Conclusion

This overview simply outlines the basics of satellite positioning. For more detailed information, visit the TPS website at www.topconpositioning.com.

GRS-1 Overview

The GRS-1 is a fully integrated hand-held controller and GPS+GLONASS L1 receiver. Integrated into the unit is a 72 channel dual frequency GPS and Glonass receiver, and electronic compass, digital camera and optional cellular modem for internet connections.

The hand-held controller component of the GRS-1 includes the Windows® Mobile operating system and color LCD touch screen. Integrated Bluetooth® and Wi-Fi wireless LAN technology allows this system to be easily connected to other Topcon sensors or wireless networks. The casing is durable and built for rugged use.

As a field controller, the GRS-1 can run a full suite of field software for working with total stations and RTK GPS systems.

The GPS+ receiver component of the GRS-1 can receive and process GPS+GLONASS L1 and L2 signals improving the accuracy of your survey points and positions. The GPS+ features of the receiver combine to provide a positioning system accurate for any survey. Several other features, including multipath mitigation and co-op tracking, provide under-canopy and low signal strength reception.

When power is turned on and the receiver self-test completes, the receiver's 72 channels initialize and begin tracking visible satellites. Each of the receiver's channels can be used to track any one of the GPS or GLONASS signals. The number of channels available allows the receiver to track all visible GPS and Glonass satellites at any time and location.

An internal L1 GPS+Glonass antenna equipped with a low noise amplifier (LNA) and the receiver's radio frequency (RF) device are connected with a coaxial cable. The wide-band signal received is down-converted, filtered, digitized, and assigned to different

channels. The receiver processor controls the process of signal tracking.

After the receiver locks on to four or more satellites, it is possible to solve the so-called “absolute positioning problem” and compute the receiver’s coordinates (in WGS-84) and the time offset between the receiver clock and GPS time. With the collection of enough information to solve for position and time the receiver can solve an RTK position if provided with a differential correction from a base station or network, or the raw observation data may be stored in the optional SD card or to the internal memory of the unit for later post processing with a post-processing software package such as Topcon Tools.

Capabilities of the GRS-1 receiver include:

- Multipath reduction
- Satellite Based Augmentation Systems supported (WAAS and EGNOS)
- Dual-frequency static, kinematic, and Real time kinematic (RTK) survey modes (Use to external GNSS antenna MG-A8 or PG-A1)
- Single-frequency static, kinematic, and differential GPS (DGPS) survey modes
- Setting different mask angles
- Setting different survey parameters

The integrated 2 megapixel camera is used for taking pictures of surveyed objects or survey sites.

Getting Acquainted with the GRS-1

The GRS-1 is an integrated field controller and 72-channel GPS receiver with an internal electronic compass and digital camera. USB and serial ports, along with Bluetooth® and Wireless LAN provide

communication paths with other devices. An external GNSS antenna connection allows for an optional MG-A8 or PG-A1 dual-frequency antenna to be connected for RTK surveying applications.

The standard GRS-1 package contains the following items:

- GRS-1 integrated receiver/controller activated for GPS+Glonass L1 signals
- Lithium-ion BT-66Q battery
- Stylus pen
- Power adapter and US to EURO adapter
- USB cable (USB A - Mini B) and power adapter cable
- Hand strap, neck strap, and soft case
- Software CD and operator's manual CD
- One-year warranty card

For more details on accessories and options available for the GRS-1, contact your local Topcon dealer.

Rechargeable and Backup Batteries

The GRS-1 comes equipped with a rechargeable battery (Figure 1-2) for powering the unit. The user can charge the battery in the unit or in an optional battery charger. A backup battery is also located in the battery pocket.

The battery provides seven hours of operation, depending on the mode of the receiver. Under normal conditions, the backup battery provides eight to ten years of power backup for data and system

integrity. For more information, see “Powering the GRS-1” on page 2-2.

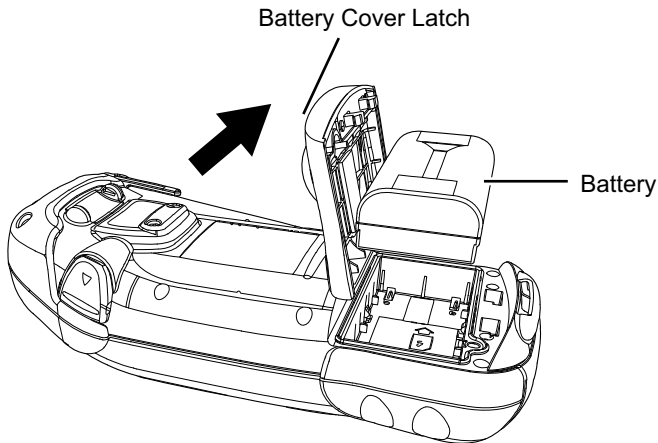

Figure 1-2. GRS-1 Battery

GRS-1 Front

The front of the GRS-1 (Figure 1-3 on page 1-12) is the primary interface with its components and installed software.

- The **internal GPS antenna** detects signals from GPS+ satellites and sends them to the GPS receiver board for processing.
- The **display screen and touch panel** provides a graphical and tactile user interface for the unit.
- The **power button** turns the receiver on and off.
- The **ESC (escape) button** exits from the current screen or function. Pressing this button for one second or more opens the Microsoft Windows Start menu.
- The **ENT (enter) button** applies settings, numerical values, and records points (depending on the settings of internal software).
- The **Bluetooth LED/Wireless LAN LED** the status of the wireless technology module:

- Blue blink: Bluetooth is on.
- Red blink: wireless LAN is on.
- Violet blink: notification from Windows.
- No light: the module is off.
- The **charging LED** indicates the level of charge in the battery:
 - Green: battery has a full charge.
 - Red: battery is charging.
 - Red blink: charging error.
- The Cell phone modem LED indicates the receiving status in the cell phone modem.
 - No light: Cell phone is off.
 - Green: Cell phone is **available**.
 - Red: Cell phone is in dead space.

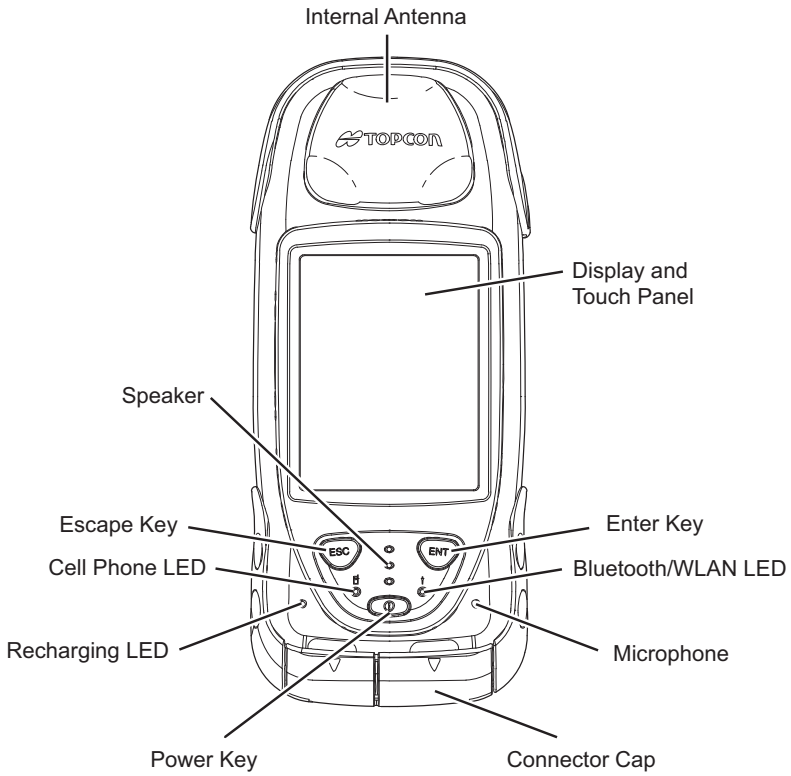

Figure 1-3. GRS-1 Front

GRS-1 Back

The back of the GRS-1 holds the stylus used for tapping on the display screen. An elastic strap provides comfortable security while using the GRS-1. A cover accesses the rechargeable battery and backup battery.

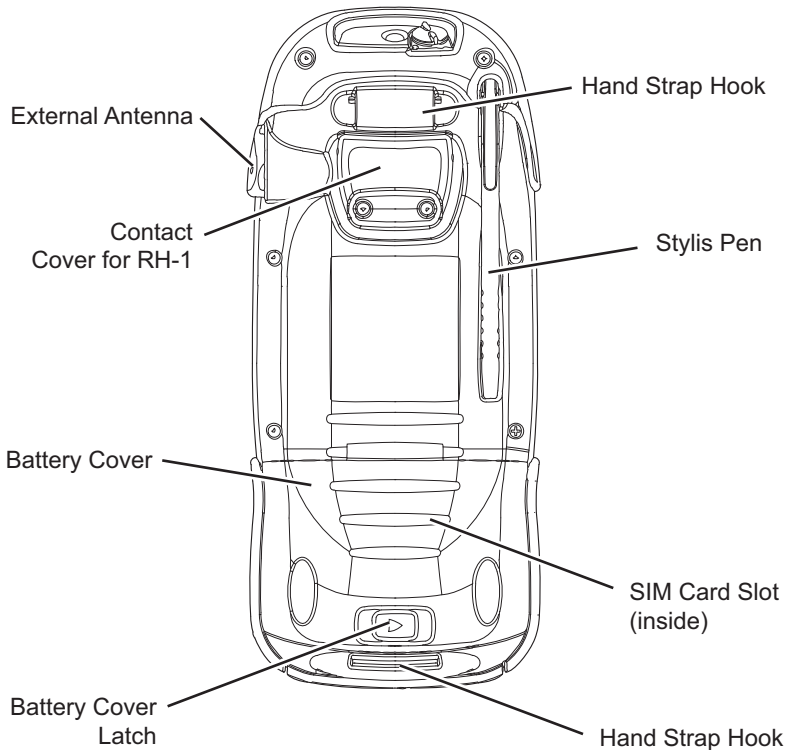

Figure 1-4. GRS-1 Back

GRS-1 Ports

The GRS-1 has the following three ports:

- USB – used for high-speed connection to a computer via ActiveSync.
- Serial – used for communication between the internal GPS module (port A of the module) and an external device.
- Power – used to connect the GRS-1 to an external power source. This port can also be used to charge the batteries.

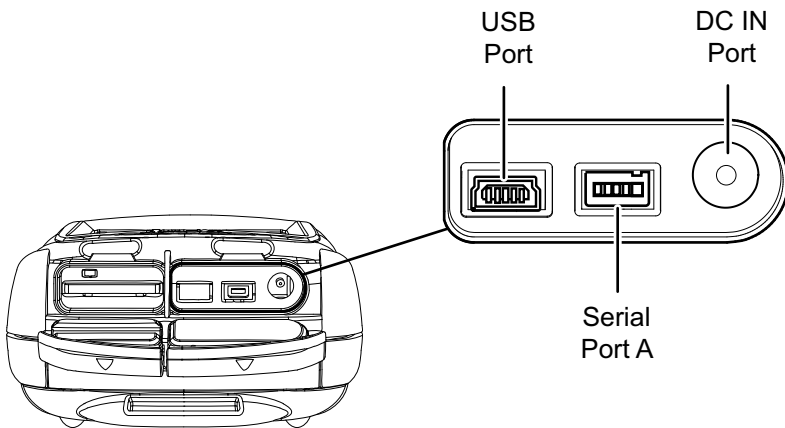

Figure 1-5. GRS-1 Ports

SD Card Slot

The SD (secure digital) slot provides extended memory for the controller (Figure 1-6). The user can access the data that resides on the SD card via the USB port, serial port, or Bluetooth® wireless technology. A secure digital card can be purchased at your local computer supply store.

Located above the card slot is the software reset button for restarting the operating system if the software is not responding.

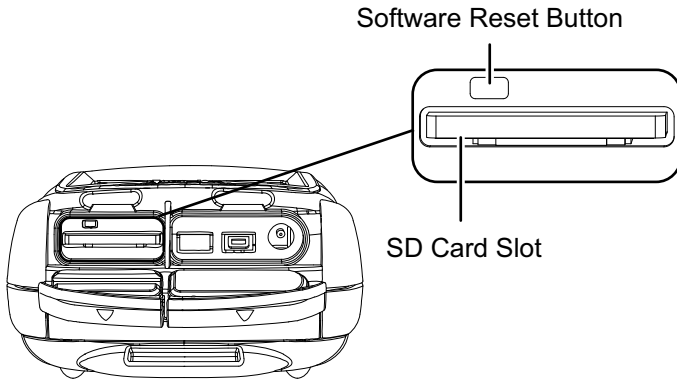

Figure 1-6. SD Card Slot

Integrated Camera

The integrated 2 megapixel camera can be used for taking pictures.

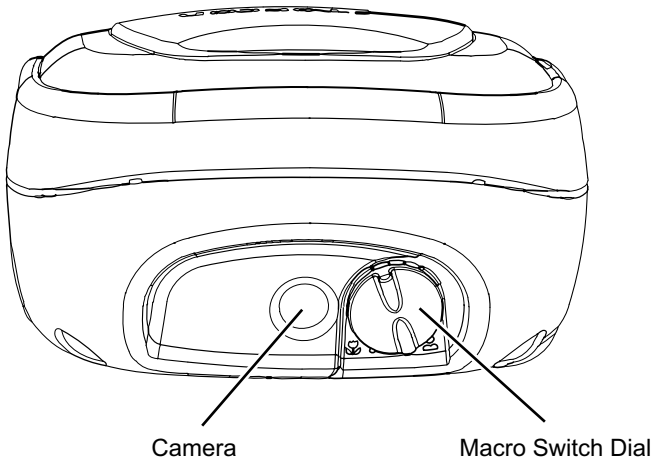

Figure 1-7. GRS-1 Camera

External GPS Antenna Connector

The external GPS antenna connector allows an optional external antenna to be connected to the controller for RTK and post-process survey applications.

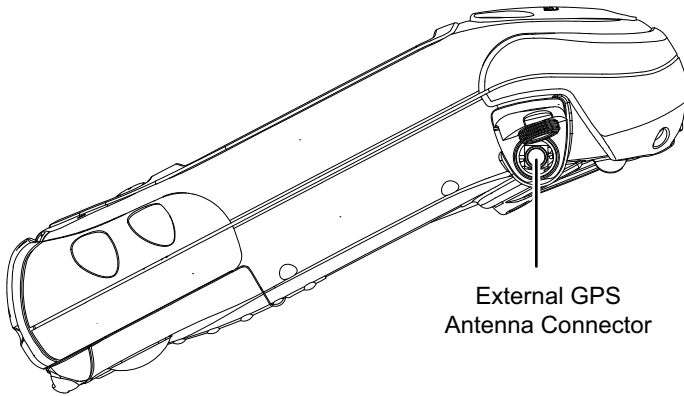
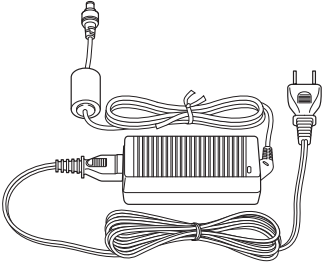



Figure 1-8. GRS-1 External GPS Antenna Connector

System Cables

The GRS-1 package includes standard communication and power cables for communicating with the GRS-1 and providing a power source. Table 1-1 lists the cables included in the standard GRS-1 package.

Table 1-1. GRS-1 Package Cables

Cable Description	Cable Illustration
<p>AC Power cable and adapter</p> <p>Connects the GRS-1 to a grounded outlet.</p> <p>Cable p/n 22-060002-01 Adapter p/n 22-060001-01</p>	
<p>USB cable</p> <p>Connects the GRS-1 to an external device (controller or computer) for high-speed data transfer and receiver configuration.</p> <p>p/n 14-008081-01</p>	

GRS-1 Software

The GRS-1 comes with the following factory-installed software:

- **BTManager** – a utility that manages and controls the Bluetooth module inside the GRS-1. BTManager connects the GRS-1 and other Bluetooth-enabled devices. For more information, see “Connecting the GRS-1 and a Bluetooth Device” on page 3-4 and “Using the Bluetooth Manager” on page 5-1.
- **Topcon Receiver Utility** – a utility that manages and controls the compass and GNSS settings. For more information, see “Surveying with the GRS-1 Using Topcon Receiver Utility” on page 5-1.

(TRU)” on page 3-6 and “Using the GNSS Compass, Camera” on page 4-1.

- Topcon Communication Manager - TPS Connection Manager is Topcon’s tool that comes on the GRS-1 field controller to setup the internal GSM modem for new network connections in Windows Mobile 6.1.

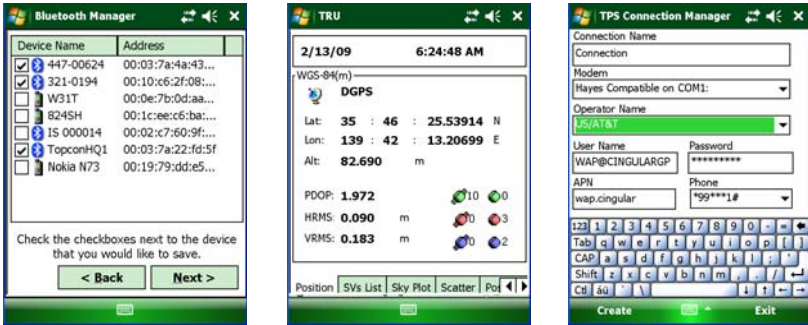

Figure 1-9. BT Manager, Topcon Receiver Utility, and Communication Manager

Optional Accessories

Table 1-2 gives a brief list of optional accessories that can be used with the GRS-1. Contact your dealer to purchase optional accessories.

Table 1-2. GRS-1 Optional Accessories

Accessory	Illustration
<p>External GNSS Antenna for GIS, and Cable</p> <p>Connecting an external PG-A5 GNSS antenna increases the range of the GRS-1.</p> <p>PG-A5 p/n 01-844201-07</p>	

Table 1-2. GRS-1 Optional Accessories (Continued)

Accessory	Illustration
<p>External Dual-Frequency GNSS Antenna for Static and RTK, and Cable</p> <p>Connecting an external PG-A1 GNSS antenna increases the range of the GRS-1.</p>	 <p>The illustration shows a coiled cable with connectors at both ends on the left, and a flat, disc-shaped antenna unit with a small protrusion on the right.</p>
<p>External Dual-Frequency GNSS Antenna for Static and RTK, and Cable</p> <p>Connecting an external MG-A8 GNSS antenna increases the range of the GRS-1.</p>	 <p>The illustration shows a coiled cable with connectors at both ends on the left, and a spherical antenna unit mounted on a vertical cylindrical base on the right.</p>
<p>Radio Holder</p> <p>Connecting the RH-1 radio holder enables transmit/receive of correction data for RTK.</p>	 <p>The illustration shows a rugged, rectangular radio holder with a long, thin antenna extending from the top. It has various ports and a handle on the side.</p>

Table 1-2. GRS-1 Optional Accessories (Continued)



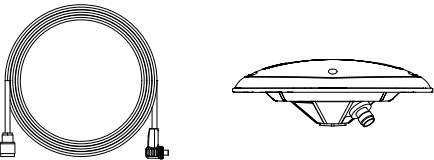

Accessory	Illustration
<p>Battery Holder</p> <p>Connecting the BH-1 battery holder enables long life operation of the GRS-1.</p>	
<p>Serial Cable</p> <p>Connects the GRS-1 to an external device (controller or computer) for data transfer and receiver configuration.</p> <p>p/n 14-008080-01</p>	
<p>BR-1</p> <p>The BR-1 is a receiver that detects signals from local Beacon stations. When connected to the GRS-1, it provides correction data.</p> <p>p/n 01-852001-01</p>	
<p>Lighter Adapter Cable</p> <p>Connects the GRS-1 to an automobile cigarette lighter for power supply</p> <p>p/n 14-008148-01LF</p>	

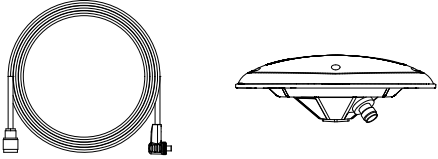
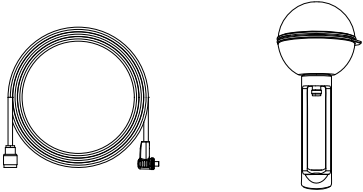
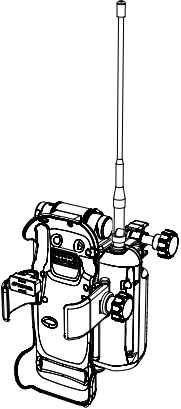
Table 1-2. GRS-1 Optional Accessories (Continued)

Accessory	Illustration
<p>Serial Cable for Modem Connects the GRS-1 to an external modem. p/n 14-008104-01LF</p>	
<p>Serial Cable for External Receiver Connects the GRS-1 to a Topcon GPS+ receiver. p/n 14-008103-01LF</p>	
<p>Battery Charger Charges the BT-66Q battery. p/n 60565</p>	
<p>Optional Software TopSURV, TopGIS, Field Tools for ArcPad, Pocket-3D, and Pocket Layout.</p>	

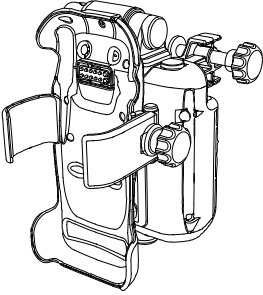
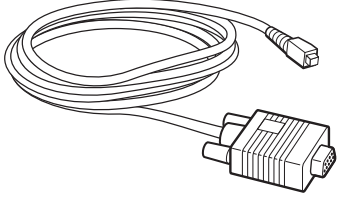
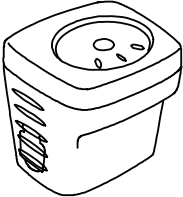
Option Authorization File (OAF)

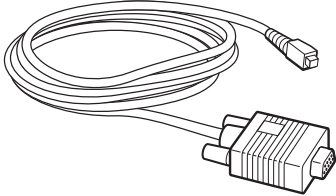
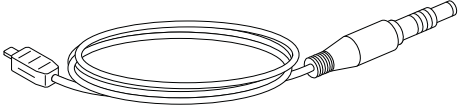
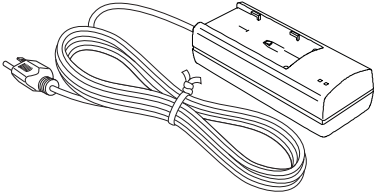
Topcon Positioning Systems issues an Option Authorization File (OAF) to enable the specific options that customers purchase. An Option Authorization File allows customers to customize and configure the receiver according to particular needs, thus only purchasing those options needed.

Typically, all receivers ship with a permanent OAF. When the receiver is purchased, a new OAF permanently activates the desired, purchased options. Receiver options remain intact when clearing the NVRAM or resetting the receiver.

The OAF enables the following functions. For a complete list of available options and details, visit the TPS website or consult your TPS dealer.

- Type of signal (standard GPS L1 and GLONASS L1)
(At using internal single frequency antenna)
- Type of signal (optional GPS/GLONASS L2, GPS L2C)
(At using external dual frequency antenna)
- RTCM Input/Output (standard)
- Satellite Based Augmentation Systems supported (WAAS and EGNOS)
- RTK at 1Hz, 5Hz, 10Hz, 20Hz, 50Hz, and 100Hz
- Advanced multipath reduction (optional)

Handling Precautions

- Make sure the GRS-1 is functioning correctly with normal performance before using it.
- Always make sure the GRS-1 is dry before putting it in the soft case.
- Do not leave the GRS-1 under strong sunlight for a long time. It may cause the device to malfunction.

- To ensure IP66 weather proofing, make sure that all of the caps are closed securely on the unit. (The external antenna connector has been sealed and will maintain ingress protection from the elements whether cap is closed or not for external antenna operations.)

Storing the GRS-1

- Always clean the GRS-1 after use.
- Use a clean cloth moistened with neutral detergent or water.
- Never use an abrasive cleaner, ether, thinner benzene, or other solvents.
- Always make sure the GRS-1 is completely dry before storing it. Dry any moisture with a soft, clean cloth.

Preparing the GRS-1 for Use

Before using the GRS-1, make sure the battery is fully charged. If you are using other survey software, such as TopSURV, install it in the office. Insert an optional SD card before beginning to survey.

Attaching the Hand Strap

The hand strap provides a comfortable, secure support for using the GRS-1 on the job. The velcro extender at the bottom of the strap allows for comfortable re-adjustment of the strap for larger or smaller hands.

To attach the hand strap, thread the bottom end of the strap through the hook on the bottom of the GRS-1 and press the velcro together. Gently stretch the strap, and insert the metal end of the strap into the strap slot on the back of the GRS-1.

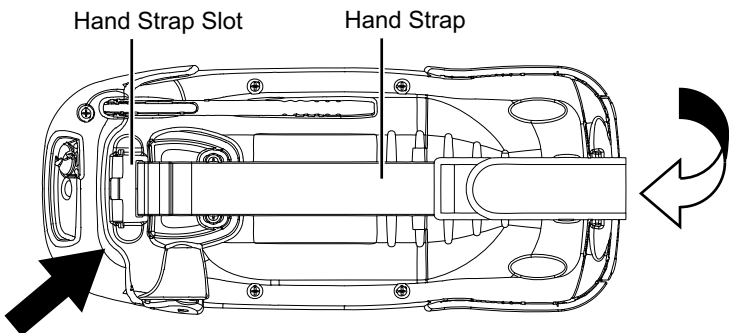

Figure 2-1. Attaching the Hand Strap

When replacing the battery, remove the top end of the strap to access the battery door latch.

Powering the GRS-1

The GRS-1 uses a BT-66Q battery for its primary power source. When using the GRS-1 for static surveys, the battery will last up to four hours. The battery will last up to fifty hours during continuous standby use (that is, no GPS usage, the display LED is off, and the touch screen is not being used). A backup coin battery and rechargeable battery back up the GPS and clock settings.

Installing the Battery

The rechargeable battery can be charged using the power port and AC adapter (see “Charging the Battery” on page 2-3), or either the optional wall charger or cigarette lighter adapter.

To remove/replace the battery (Figure 2-2) do the following:

1. If needed, unhook the top of the strap from the GRS-1.
2. Open the battery cover, and remove the primary battery. The GRS-1 automatically turns off when the battery cover is opened. When the battery cover is opened, the device automatically switches to suspend mode (power off).
3. Replace the battery with a fully charged one, making sure the (+) and (-) symbols on the bottom of the battery are aligned with the symbols in the battery casing.
4. Press to close the battery cover until it clicks into place, and reattach the hand strap.



If the battery cover does not close, rotate the battery 180 degrees.

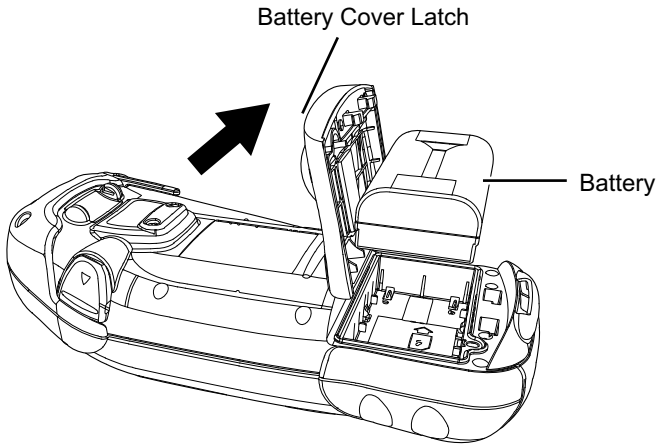

Figure 2-2. Installing the Primary Battery

Charging the Battery

The AC/DC converter AD-11 provides power to the GRS-1 and charges the primary battery. Note that using the GRS-1 while charging increases the charge time. The battery will be fully charged in approximately seven hours.

To charge the battery using the converter

(Figure 2-3 on page 2-4):

1. Plug the AC/DC converter connector into the power (DC-IN) port of the GRS-1.
2. Plug the converter into a grounded outlet.
The Charge LED lights up. The battery is fully charged after about six hours.

The charging LED indicates the level of charge in the battery:

- Green – battery has a full charge.
- Red – battery is charging.
- Red blink – charging error.



The GRS-1 may become warm during charging.

Charge LED

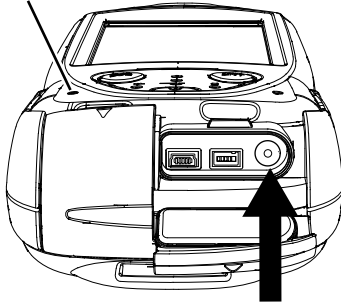

Connector

AD-11B/11C

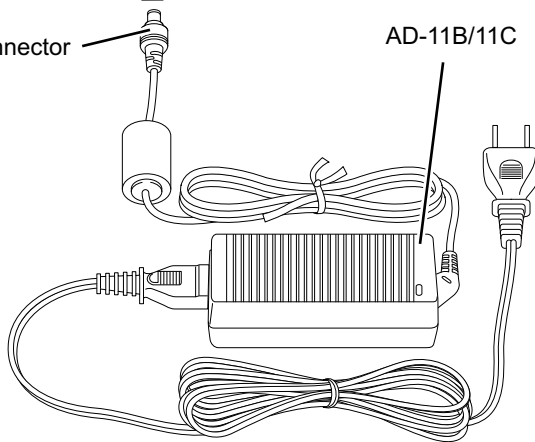

Figure 2-3. Charging the Battery in the GRS-1

To charge the battery using the optional charger (Figure 2-4):

1. Remove the battery from the GRS-1 (see “Installing the Battery” on page 2-2 for details), and insert it into the charger.

2. Plug the charger into a grounded outlet.

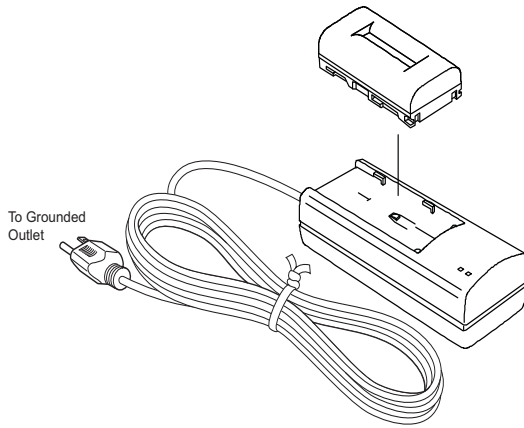

Figure 2-4. Charging the Battery in the Optional Charger

Charging and Battery Storage Notes

To keep the battery properly charged, maintained, and stored, do the following:

- Only recharge the battery at room temperature, approximately 50°F to 104°F (10°C to 40°C). Charging at a high temperature increases the time it takes to charge the battery.
- Always check the battery charge before using the GRS-1. The battery will discharge during storage.
- Charge a stored battery every seven days. Allowing a battery to become discharged can reduce the overall performance of the battery and charge efficiency.
- Be aware that the charger may become somewhat heated while charging the GRS-1.

Replacing the Backup Battery

The backup battery ensures GPS and clock settings are saved when the primary battery and internal rechargeable battery are depleted. Under normal conditions, the backup battery lasts two to three years.



The Windows Mobile RAM has a separate backup, rechargeable battery. This battery will power the RAM for five minutes after removing the primary battery.

The backup battery is a CR2032 coin battery that can be purchased at many general retailers. You will need Phillips-head and flat-head screwdrivers to replace the backup battery. Follow these steps to replace the backup battery as shown in (Figure 2-5).

1. Open the battery cover and remove the primary battery.
 2. Using a Phillips-head screwdriver, remove the coin battery/SIM card cover.
 3. Using a flat-head screwdriver, insert the tip of the screwdriver in the slot to the left of the coin battery. Gently push the coin battery to the right to pop it out of the holder. Repeat these steps on the left side of the holder to remove the coin battery.
-



Replace the battery within a couple of minutes to prevent data loss.

4. Insert the new coin battery, plus side up, into the holder. Slide the coin battery under the tabs and gently push into place.
5. Replace the coin battery cover and screw.

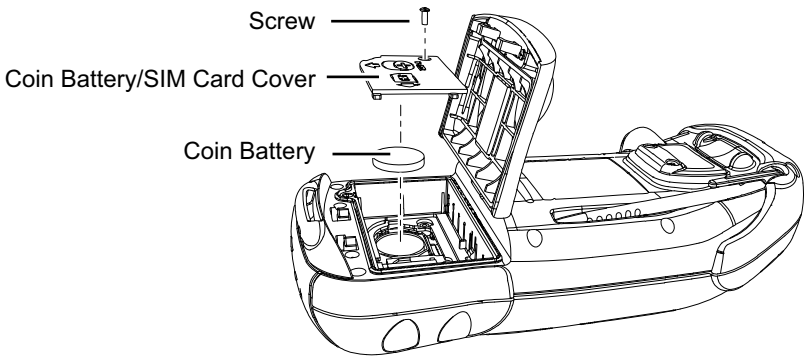

Figure 2-5. Replacing the Coin Battery

Starting the GRS-1

To start the GRS-1, briefly press the power button. The touch screen lights up, and the GRS-1 splash screen displays while the system loads, and then the Microsoft Windows Mobile desktop displays.

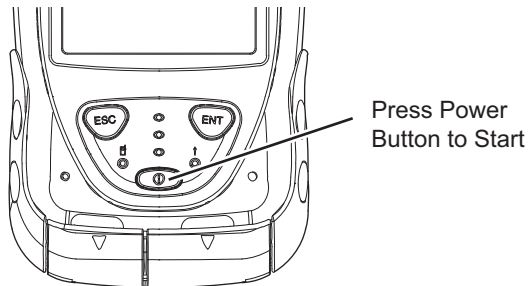

Figure 2-6. Press Power to Start the GRS-1

Calibrating the Touch Screen

The touch screen needs to be calibrated when first starting the GRS-1 or after a hard reset. The configuration function automatically starts and is simple to complete.

1. On the main screen of the GRS-1, press the **Start**  icon.

2. Press **Settings** ▶ **System tab** ▶ **Screen**

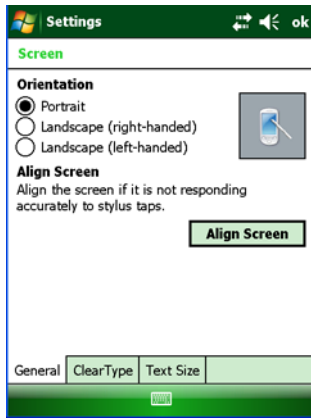

Figure 2-7. Stylus Properties

3. Press **Align Screen**.
4. Press and hold the stylus on the center (+) of the cross lines (targets) as it moves about the screen.

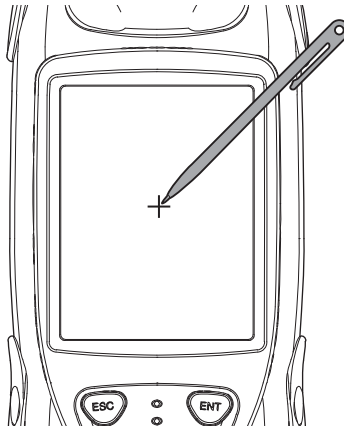



Figure 2-8. Calibrate the Touch Screen

5. Once the target stops moving and the device is recalibrated, press **OK** at the top of the screen.

Setting the Power Management

The power management feature prevents battery depletion by automatically conserving the power through the Standby (no GPS usage, the display LED is off, and the touch screen is not being used) or Suspend (power off) mode when the unit is left turned on.

To set the Standby or Suspend mode:

1. On the main screen of the GRS-1, press the **Start**  icon.
2. Press **Settings** ▶ **System** tab ▶ **Power**.
The **Power Properties** window appears with the **Advanced** tab open.

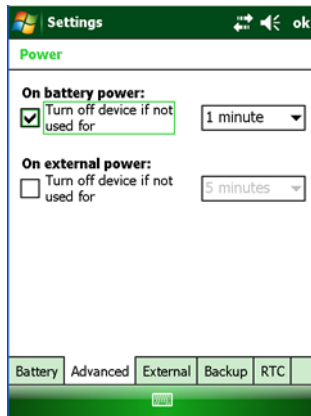

Figure 2-9. Power Properties

3. Check the **On battery power: Turn off device if not used for** check box, and then select a time from the drop-down menu. Repeat for the **On external power: Turn off device if not used for** check box and drop-down menu.
4. Press **OK** at the top of the screen.

Installing Software

The GRS-1 runs the standard Microsoft® Windows® Mobile® operating system and applications. When installing other software applications onto the GRS-1, Microsoft ActiveSync (Windows XP and earlier operating systems up to Windows 98) or Windows Device

Center (Windows Vista) is required. The following software may be useful for taking full advantage of the integrated features found in the GRS-1 controller/receiver:

- TopSURV – full-featured data collection software used on a hand held controller. TopSURV is structured into several modules to provide the user with a scalable, cost effective application that can be utilized for all Surveying tasks. Use TopSURV to measure and capture rich survey data sets with all types of Topcon sensors.
- Field Tools for ArcPad – field data collection software used on a hand-held controller for GIS surveys. It is structured to provide the surveyor with capture and update functions for geographical data in a wide range of GIS-related applications.
- Topcon Receiver Utility (TRU) – a utility that configures GPS and DGPS receivers connected to a hand-held controller.

Installing software onto the GRS-1 requires a connection to a computer that contains the software. Software is first downloaded onto a desktop/laptop computer, then installed onto a connected controller via Microsoft ActiveSync.

Refer to the corresponding manual for specific instructions to install software onto the GRS-1.

Installing Microsoft ActiveSync ActiveSync or Windows Device Center is available for free from the Microsoft website (www.microsoft.com) and must be installed on the computer before installing software onto the GRS-1.

Installing an Optional SD Card

SD (secure digital) cards can be purchased at a local computer supply store. When inserted into the GRS-1, an SD card provides additional data storage, as well as data transfer. The GRS-1 supports SD cards with up to 2 GB capacity. This device does not currently support SDHC cards.



Some SD cards may not be used with the GRS-1.

1. Open the SD card slot door.
2. Gently insert an SD card into the slot as shown in Figure 2-10.
3. Close the SD card slot door.

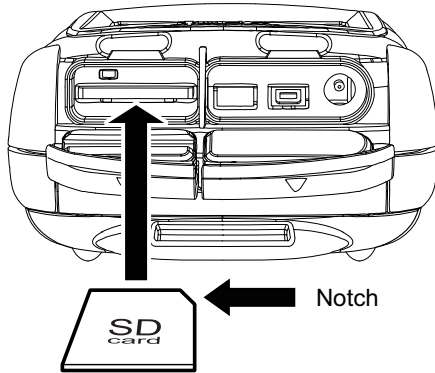

Figure 2-10. Insert SD Card

Using the GRS-1

The GRS-1 can be used as a stand-alone hand held L1 device for mapping, or with the external PG-A1 antenna as a dual frequency RTK rover. When installing software or performing file transfers, the USB cable or Bluetooth module connects the GRS-1 to a computer for in-office processing. The GRS-1 can also be used as a controller for other Topcon measurement devices such as manual and robotic total stations, digital levels, and dual frequency receivers.

Connecting the GRS-1 with Other Devices

The GRS-1 provides for direct connection to devices with either a mini serial or USB port, devices that support Bluetooth and wireless LAN operations, or with an external GNSS antenna (PG-A1, PG-A5 or MG-A8), as well as an optional internal cellular modem for network connections for either differential corrections or pushing data to the internet. The various devices are optional and can be purchased from your local Topcon dealer or at a commercial retail store for commercially sold products (such as the SD card).

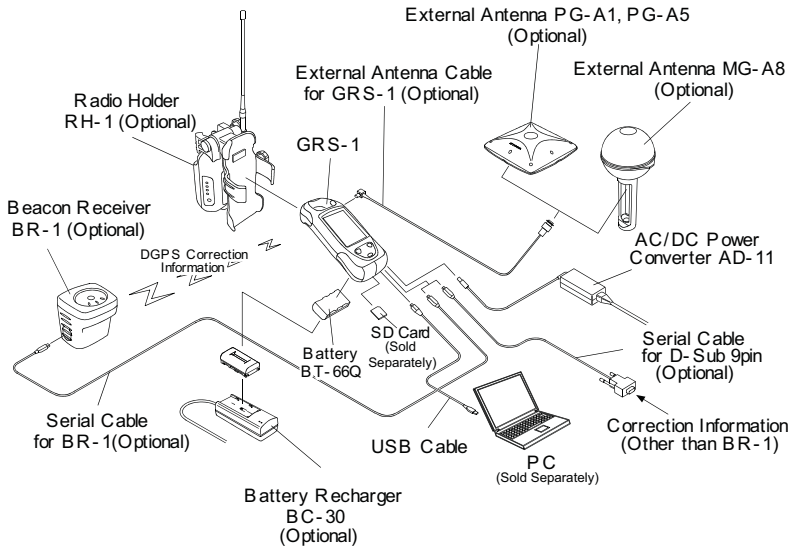

Figure 3-1. GRS-1 System Connections

Connecting the GRS-1 and a Computer

Connecting the GRS-1 and a computer allows you to install software onto the controller and upload data from the controller to a computer.

1. Before connecting the GRS-1 and a computer, make sure Microsoft ActiveSync is installed on the computer. See “Installing Software” on page 2-9 for details.



For a Bluetooth connection, see “Connecting the GRS-1 and a Bluetooth Device” on page 3-4 for details.

2. Connect the GRS-1 and the computer using the interface cable F-25 (USB) or Bluetooth wireless technology.

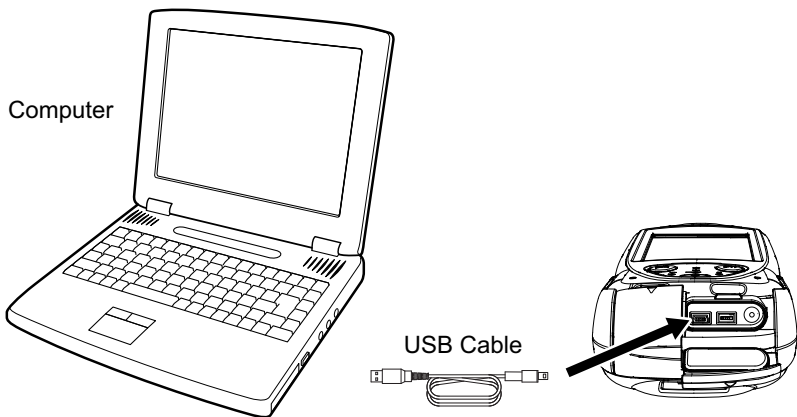

Figure 3-2. Connect GRS-1 and Computer (USB) Using Cable

3. When ActiveSync on the computer prompts to set up a partnership, select **No**, and click **Next**.
4. Once the connection has been established, click the **Explorer** icon on the ActiveSync screen to view data on the GRS-1 on-board memory.

About ActiveSync and Windows Mobile Device Center

If you are using the Windows 2000 service pack 4 or Windows XP operating system, then download ActiveSync from the Microsoft website and install it to your computer. If you are using the Windows Vista operating system, then download Windows Mobile Device Center from the Microsoft website and install it on your computer.

The method for downloading and installing ActiveSync and Windows Mobile Device Center is described at the following URL:
www.microsoft.com/windowsmobile

- ActiveSync 4.2 and 4.5 is supported by Windows 2000 service pack 4 and Windows XP.
- Windows Mobile Device Center 6.1 is supported by the Windows Vista operating system.

See the help section of the software for details on how to set up and use the software. If a connection is not possible with your computer, see the Microsoft website (<http://support.microsoft.com/kb/259369>) or contact the support center for the computer you are using.

Connecting the GRS-1 and a Bluetooth Device

The GRS-1 is equipped with Bluetooth capability, so you can transmit data wirelessly between equipment. The Bluetooth Devices screen displays the List of Favorite Devices, so you can quickly and easily connect with a saved device. If the device you are looking for is not listed, then you can search for up to nine other Bluetooth-enabled devices within range. Make sure the devices you are searching for are discoverable.

To connect with a paired device:

1. From the **Bluetooth Devices** screen, highlight a device, and press **Device ▶ Pair**.

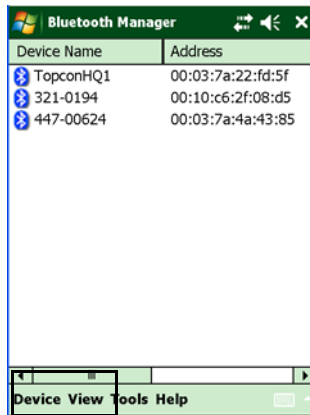

Figure 3-3. Bluetooth Devices - Select

2. If you cannot find a saved device on this screen, then press **Tools ▶ Device Discovery**. An hourglass appears while BTManager searches the List of Favorite Devices and then searches for up to nine nearby Bluetooth-enabled devices.

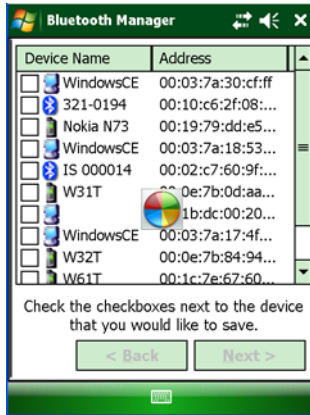

Figure 3-4. Bluetooth Devices - Discovery

3. After the devices are found, you can:
 - Select a device, and tap **Next**. You can choose more than one device.
 - A confirmation message appears when the devices are successfully added to the List of Favorite Devices.



Figure 3-5. Bluetooth Devices - Pairing

4. Pairing Bluetooth Devices
 - Select a device on My Bluetooth Device Screen.
 - Press **Device** ▶ **Pair**

- Enter the pass key.

If an error message displays upon trying to connect, then it usually means that the security settings of the remote device do not correspond to the security settings of the GRS-1.

To correct this, make sure the **Pass Key**, **Authentication**, and **Encryption** check boxes on the **My Bluetooth Device** screen correspond with the security settings of the remote device.

For more information about troubleshooting error messages, see “Bluetooth Problems” on page 7-8.

For more information about connecting devices and using Bluetooth Manager, see “Using the Bluetooth Manager” on page 5-1.

Surveying with the GRS-1 Using Topcon Receiver Utility (TRU)

The GRS-1 can be used in many surveying situations. From GIS surveying to data collection on a construction jobsite, the GRS-1 provides an integrated solution for all your needs.

Simple surveying (data collection) with the GRS-1 can be handled with the on-board TRU software. Other surveys may require an external GPS antenna and/or a Beacon receiver to acquire GPS signals or correction data for better position accuracy.

Surveying with the GRS-1

For more information on TRU, see the Topcon Receiver Utility Operator’s Manual.

1. Complete any required pre-survey steps as described in Chapter 2.
2. Open TRU, and press **Device ▶ Connect**.
3. Select **Connect Using ▶ Serial Port, Port Name ▶ Com7**.
4. Press **Connect**.

5. Open **Receiver Settings ▶ Tracking**.
6. Check the antenna, and elevation mask, and PDOP mask settings.
For typical surveys, the antenna should be set to **Internal**.
7. Press **OK**.
8. Open **Status**.
The **Position Information** window appears.
9. Press the **SVs List** tab.
The **Satellite Information** window appears.
10. Press the Sky Plot tab.
The **Sky Plot Information** window appears.

Surveying with the GRS-1 and an External Antenna

1. Complete any required pre-survey steps as described in Chapter 2.
2. Open TRU, and press **Device ▶ Connect**.
3. Select **Connect Using ▶ Serial Port, Port Name ▶ Com7**.
4. Press **Connect**.
5. Open **Receiver Settings ▶ Tracking**.

6. For the **Antenna** setting, select **External**.

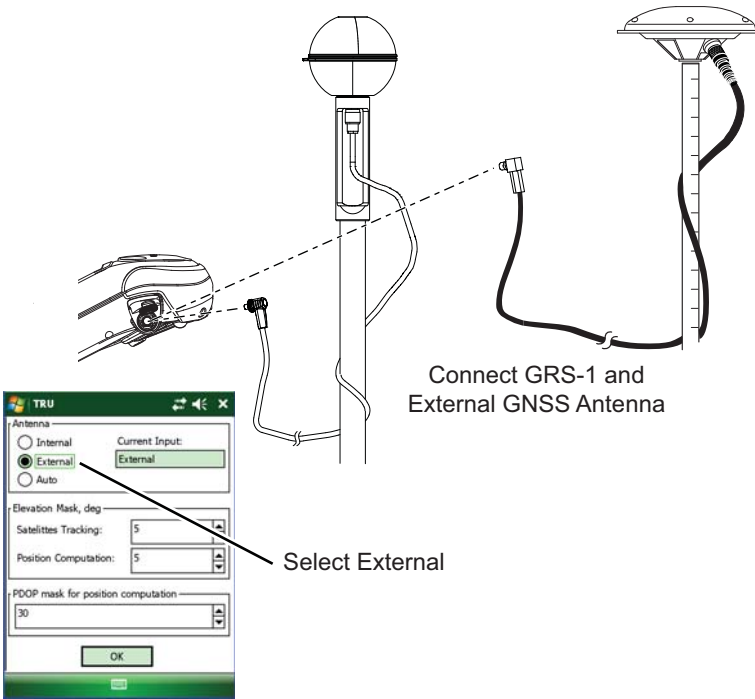

Figure 3-6. GRS-1 and PG-A1/PG-A5/MG-A8 Antenna Setup

7. Edit the interval and elevation mask settings as needed.

Surveying with the GRS-1 and a Beacon Receiver

1. Complete any required pre-survey steps as described in Chapter 2.
2. Setup the Beacon receiver according to its documentation.
3. Using BTManager, connect the GRS-1 and GPS receiver as described in “Connecting the GRS-1 and a Bluetooth Device” on page 3-4. In BTManager, the BR-1 would be considered an “Unclassified” device.

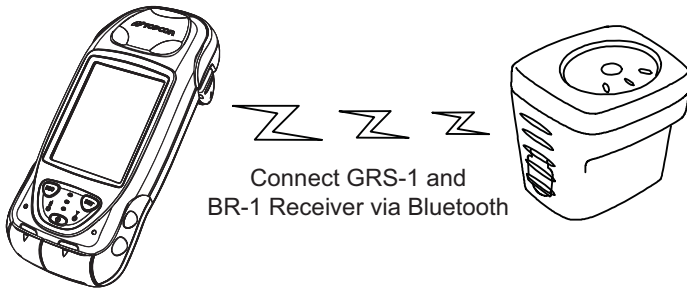

Figure 3-7. GRS-1 and BR-1 Setup

4. Configure the GRS-1 for data collection as described in the corresponding software manual. For example, if you are using Field Tools as the data collection software, then refer to the *Field Tools Reference Manual*.



Ensure the survey configuration is for an external receiver.

5. Begin logging data using the data collection software.
6. When you reach a location to record a point, pause and press the **Ent (Enter)** button on the GRS-1. Wait until the point is recorded before moving to the next location.

Surveying with the GRS-1 and an External GPS Receiver

This setup uses Bluetooth wireless technology for communication between the GRS-1 and a GPS receiver.

1. Complete any required pre-survey steps as described in Chapter 2.
2. Setup the external GPS receiver according to its documentation.
3. Using BTManager, connect the GRS-1 and GPS receiver as described in “Connecting the GRS-1 and a Bluetooth Device” on

page 3-4. In BTManager, the GNSS receiver would be considered an “Unclassified” device.

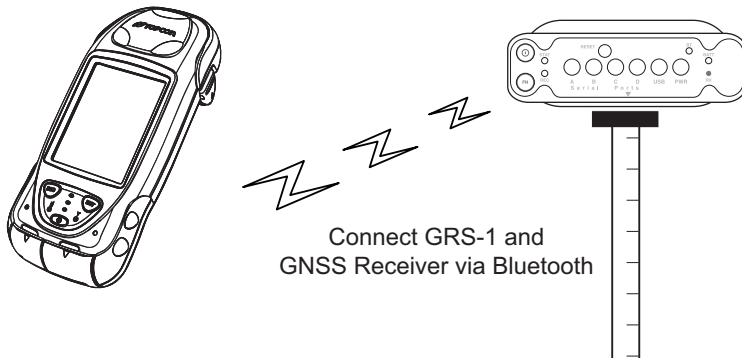

Figure 3-8. GRS-1 and HiPer Series Receiver Setup (Using Bluetooth)

4. Configure the GRS-1 for data collection as described in the corresponding software manual. For example, if you are using TopSURV as the data collection software, refer to the *TopSURV Reference Manual*.



Ensure the survey configuration is for an external receiver.

5. Via the data collection software, begin logging data.
6. When you reach a location to record a point, pause and press the **Ent (Enter)** button on the GRS-1. Wait until the point is recorded before moving to the next location.

Using the GNSS Compass, Camera

Topcon Receiver Utility

Topcon Receiver Utility for GRS-1 is a simple utility that manages the compass and receiver board settings in the GRS-1. When first opening Topcon Receiver Utility or after a reset, all settings will be at the default selections. Typical GNSS settings only need to be configured once. Occasionally, individual uses may require different settings. Topcon Receiver Utility saves logged satellite information. Table 4-1 summarizes the screens and settings in Topcon Receiver Utility.

Table 4-1. Topcon Receiver Utility Screens

Description	Screen																																																																																											
<p>Status</p> <p>The Status screen displays the current position, satellite information, sky plot, and position in time.</p>	 <p>The screenshot shows the TRU Status screen with a table of satellite data. The table has columns for SVC, USI, EL, AZ, CA, L1P, and L2P. The rows are color-coded: green for GPS, red for GLO, and blue for SBAS. The bottom of the screen has a menu bar with options: Position, SVs List, Sky Plot, Scatter, and Pod.</p> <table border="1" data-bbox="572 930 887 1266"> <thead> <tr> <th>SVC</th> <th>USI</th> <th>EL</th> <th>AZ</th> <th>CA</th> <th>L1P</th> <th>L2P</th> </tr> </thead> <tbody> <tr><td>GPS</td><td>8</td><td>41+</td><td>98</td><td>47</td><td>18</td><td>18</td></tr> <tr><td>GPS</td><td>10</td><td>62+</td><td>334</td><td>51</td><td>28</td><td>28</td></tr> <tr><td>GPS</td><td>15</td><td>31+</td><td>234</td><td>46</td><td>18</td><td>17</td></tr> <tr><td>GPS</td><td>24</td><td>29+</td><td>314</td><td>45</td><td>13</td><td>14</td></tr> <tr><td>GPS</td><td>26</td><td>49+</td><td>232</td><td>50</td><td>24</td><td>25</td></tr> <tr><td>GPS</td><td>27</td><td>41+</td><td>142</td><td>47</td><td>19</td><td>20</td></tr> <tr><td>GPS</td><td>29</td><td>22+</td><td>298</td><td>41</td><td>10</td><td>10</td></tr> <tr><td>GLO</td><td>43</td><td>21-</td><td>38</td><td>37</td><td>35</td><td>??</td></tr> <tr><td>GLO</td><td>49</td><td>44+</td><td>94</td><td>39</td><td>39</td><td>??</td></tr> <tr><td>GLO</td><td>51</td><td>50-</td><td>22</td><td>41</td><td>40</td><td>30</td></tr> <tr><td>SBAS</td><td>129</td><td>??</td><td>??</td><td>44</td><td>??</td><td>??</td></tr> <tr><td>SBAS</td><td>137</td><td>??</td><td>??</td><td>45</td><td>??</td><td>??</td></tr> </tbody> </table>	SVC	USI	EL	AZ	CA	L1P	L2P	GPS	8	41+	98	47	18	18	GPS	10	62+	334	51	28	28	GPS	15	31+	234	46	18	17	GPS	24	29+	314	45	13	14	GPS	26	49+	232	50	24	25	GPS	27	41+	142	47	19	20	GPS	29	22+	298	41	10	10	GLO	43	21-	38	37	35	??	GLO	49	44+	94	39	39	??	GLO	51	50-	22	41	40	30	SBAS	129	??	??	44	??	??	SBAS	137	??	??	45	??	??
SVC	USI	EL	AZ	CA	L1P	L2P																																																																																						
GPS	8	41+	98	47	18	18																																																																																						
GPS	10	62+	334	51	28	28																																																																																						
GPS	15	31+	234	46	18	17																																																																																						
GPS	24	29+	314	45	13	14																																																																																						
GPS	26	49+	232	50	24	25																																																																																						
GPS	27	41+	142	47	19	20																																																																																						
GPS	29	22+	298	41	10	10																																																																																						
GLO	43	21-	38	37	35	??																																																																																						
GLO	49	44+	94	39	39	??																																																																																						
GLO	51	50-	22	41	40	30																																																																																						
SBAS	129	??	??	44	??	??																																																																																						
SBAS	137	??	??	45	??	??																																																																																						

Table 4-1. Topcon Receiver Utility Screens (Continued)

Description	Screen
<p>Receiver Settings</p> <p>The receiver settings (tracking options) screen selects the antenna (internal or external), elevation mask, and PDOP mask.</p>	
<p>Tools</p> <p>The tools screen allows you to clear the NVRAM and reset the receiver.</p>	

Table 4-1. Topcon Receiver Utility Screens (Continued)

Description	Screen
<p>Receiver Options</p> <p>The receiver options screen displays an Option Authorization File (OAF) information and allows you to upload an OAF file.</p>	
<p>Compass</p> <p>The Compass tab in GMS/GRS Tools displays the magnetic North direction. The angle to North displays the pitch and roll of the unit and calibrates the compass.</p>	

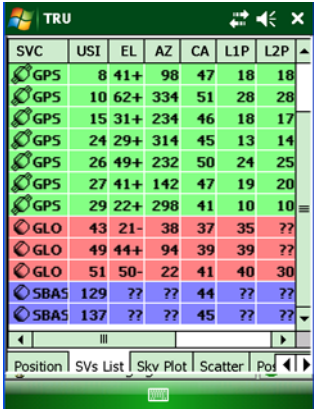
Using the Compass

Press **Start** ▶ **TRU** ▶ **Device** ▶ **GMS/GRS Tools**.

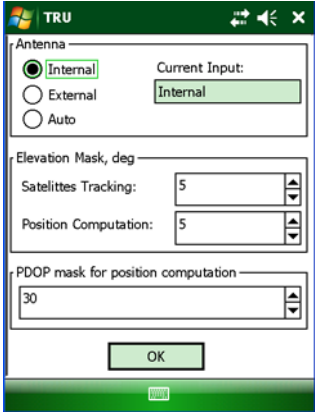
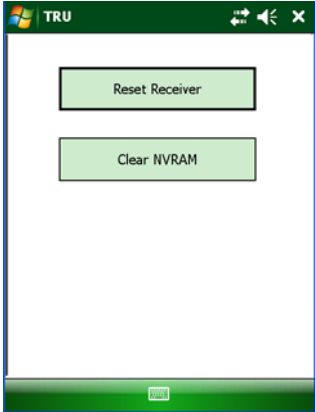
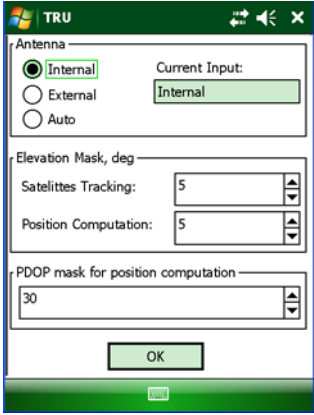
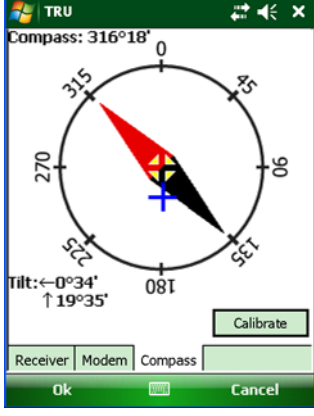
The Compass tab displays the current direction, roll, and pitch of the GRS-1. This tab also calibrates the compass.

- Pointer – North (red portion of pointer) and South (black portion of pointer) directions.

- Angle – the angle (azimuth) from North, in degrees.
- Tilt – the roll and pitch, from level, in degrees minutes.

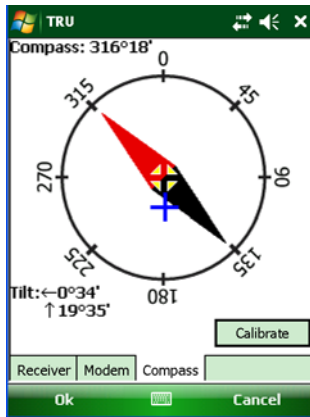

Figure 4-1. View the Compass

Declination is the angle between magnetic north and true north. The compass shows magnetic north. In order to determine the coordinates, it is necessary to correct the declination.

Inclination is downward in the northern hemisphere. Because the compass detects the horizontal component of a magnetic field, azimuth accuracy worsens in the high magnetic area where a magnetic horizontal component is small.

The compass function can be used in the area within +/- 70 degrees magnetic latitude.

Magnetic Field Distortions occurs near ferrous materials and material that disturbs a magnetic field, such as:

- The inside and surrounding area of a railroad, car, and ferro-concrete building.
- A magnet, motor, and electric products, including digital camera, personal computer, data collector, etc.
- The surrounding area of a plant that induces a magnetic field like a high-voltage line and substation.
- The surrounding area of a metal (iron, nickel, and cobalt) mine.

- A wrist watch. (Keep a distance of 15 cm or more between the GRS-1 and a wrist watch.)

Because azimuth accuracy worsens near ferrous materials as described above, correct the azimuth by methods other than magnetism. For example, you can:

- Determine the coordinates of two points from the DGPS function. (The distance of two points must be 120 m or more.)
- Determine the right azimuth from two known points on a map.



Do not use an AC/DC adaptor at the time of compass use.

Calibrating the Compass

Calibrate each location before starting the measurement for an accurate value.

When the unit is turned on, the previous calibration will be used. See also “Recalibrating the Compass” on page 4-8.

To calibrate the compass:

1. Open TRU, and press **Device** ▶ **GMS/GRS Tools** ▶ **Compass** tab.

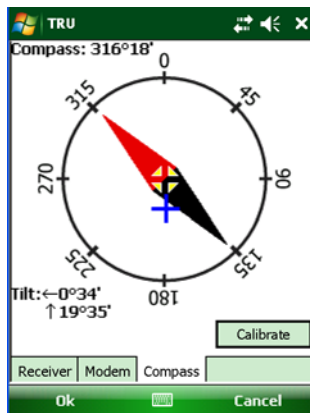

Figure 4-2. Compass Tab

2. Press **Calibrate**, and then start the calibration as shown in Figure 4-3.

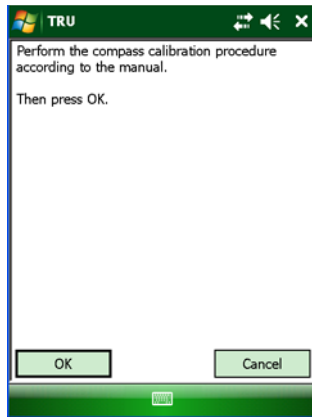

Figure 4-3. Begin Compass Calibration

3. Hold the GRS-1 horizontally in your hand and turn to any direction.
4. Rotate the device 360 degrees in a horizontal direction for five or more seconds. See Figure 4-4.
5. Rotate the device 360 degrees in a roll direction for five or more seconds. See Figure 4-4.
6. Rotate the device 360 degrees in a pitch direction for five or more seconds. See Figure 4-4.
7. Turn your body 90 degrees in any direction, and repeat steps 4, 5, and 6.

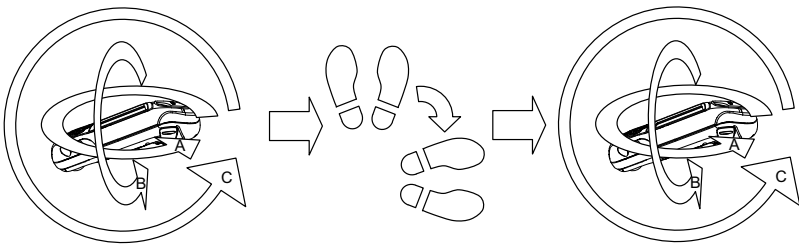

Figure 4-4. Calibrating the Compass

8. Press **OK**.

If calibration is successful, the *Calibration completed successfully* window appears, and the calibration value is saved. Press **OK**.

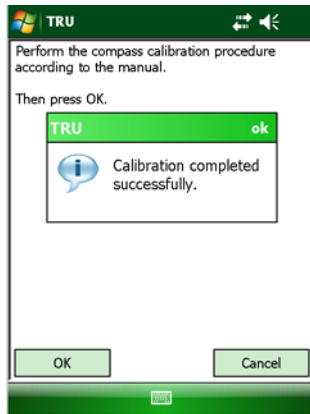

Figure 4-5. Calibration Successful

If you did receive an error message, then you may have rotated the device too quickly or in the wrong direction. Try to recalibrate the compass.

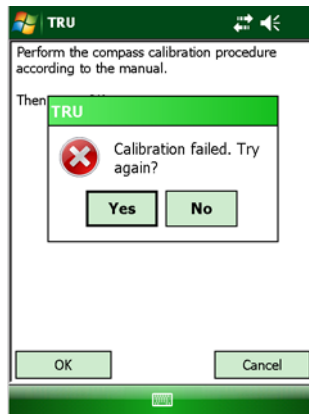

Figure 4-6. Calibration Error

If a calibration error appears several times, change the direction a little and try again.

Recalibrating the Compass

Recalibration is needed in the following cases:

- The survey location changes frequently.
- The GRS-1 receives a shock, such as being dropped.
- The temperature changes 10 degrees or more.
- The device is transported by car or airplane.
- The device is attached to metal objects, such as a tripod and a pole.
- The battery is exchanged.
- The magnetic field changes, such as an approaching car.
- The device is near a strong magnetic object or material, such as a permanent magnet, electromagnet, motor, transformer, AC power supply, speaker, etc.

Viewing GNSS Information and Settings

For more GNSS information and settings on TRU, see the Topcon receiver Utility Operator's Manual.

Using the Camera

To take a picture:

1. Press Start -> Pictures & Videos.

2. Press the Camera icon.

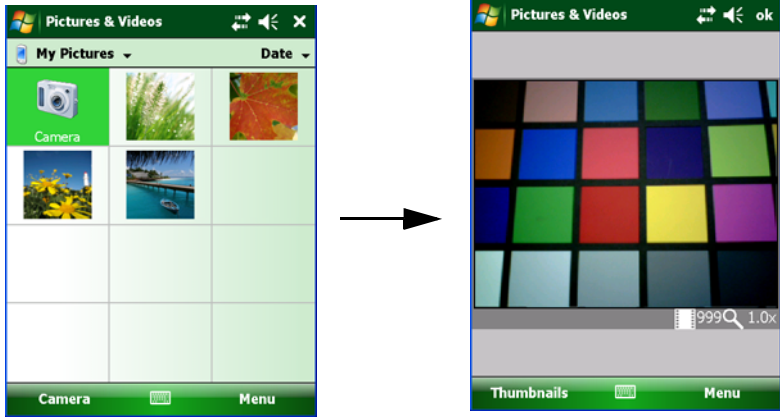

Figure 4-7. Take a picture

3. Aim the camera at the desired object(s), using the finder/review pane to frame the image.
4. Press the **ENT** key on the GRS-1 to take the picture.
5. Press **Thumbnails**.
6. Check to save the picture.

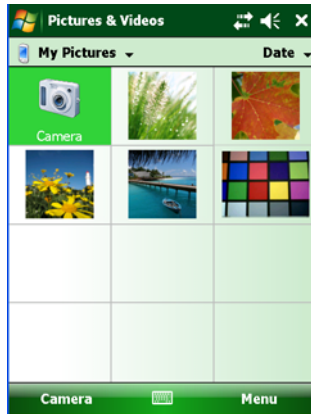

Figure 4-8. Save a picture

Adjust camera settings using the following selections:

Press **Menu** on the camera finder screen.

- **Brightness** – Select a brightness of the captured image. Settings are from -3 to +3.
- **Resolution** – select the resolution in bits of the image to capture. Settings are from 160x120 to 1600x1200.
- **Zoom** – select the scaling factor. Settings are from zoom 1 to 4.



Figure 4-9. Adjust Camera Settings

To set the macro and long distance modes: turn the dial to the left for macro mode and to the right for long distance mode as shown in Figure 4-10.



Do not use the camera with the camera dial set halfway between the macro and long distance mode settings.

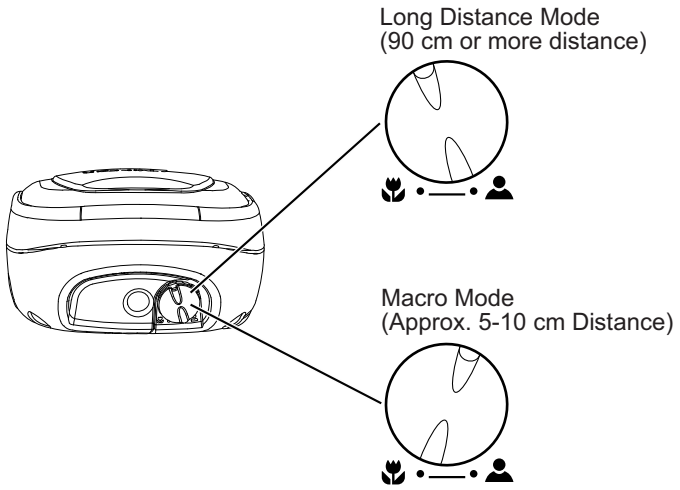

Figure 4-10. Camera Dial Modes

Using the Bluetooth Manager

The BTManager utility controls the GRS-1 Bluetooth module.

Getting Started

To start BTManager:

1. Turn on the GRS-1.
2. Press the Bluetooth icon in the system tray, and select **Bluetooth Manager** from the pop-up menu.

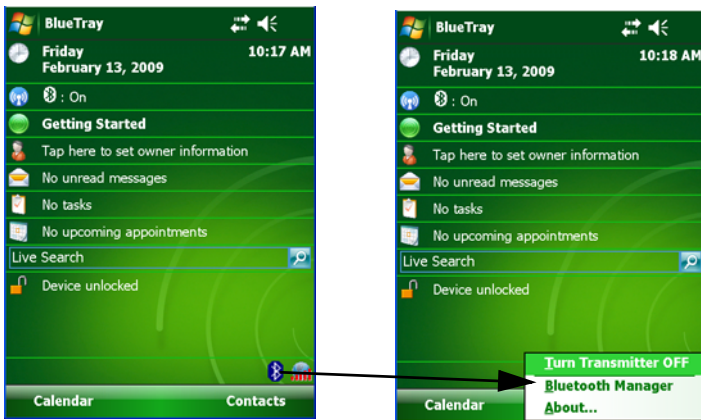

Figure 5-1. Starting Bluetooth Manager

3. If the Bluetooth transmitter is switched off (The Bluetooth icon is gray.), select **Turn Transmitter On** to turn on Bluetooth.

Getting Acquainted

Table 1-1 summarizes the screens and settings in BTManager.

Table 5-1. BTManager Screens

Description	Screen
<p>Type of devices to detect</p> <p>This screen displays types of devices to discover. Once a device type is selected, the <i>Discovery Wizard</i> searches for those devices when you tap Next.</p>	
<p>Device List</p> <p>This screen displays all discovered devices of a selected type. From this list, you can choose a device to add to your <i>List of Favorite Devices</i> by tapping Next.</p>	

Table 5-1. BTManager Screens (Continued)



Description	Screen
<p>List of Favorite Devices</p> <p>This screen displays your preferred Bluetooth-enabled devices. You can use the Device Discovery wizard option in the Tools menu or the Bluetooth Devices screen to search for Bluetooth-enabled devices within range and save them to this list for future connections.</p>	
<p>My Bluetooth Device</p> <p>This screen displays the internal GRS-1 Bluetooth module information. On this screen, you can set your preferences and choose how to connect with other devices.</p>	

Table 5-1. BTManager Screens (Continued)

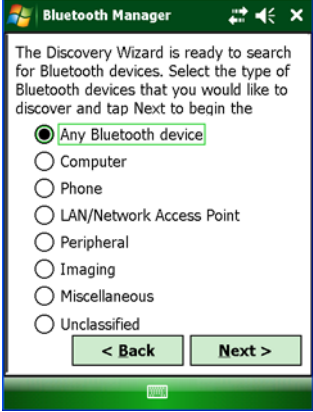
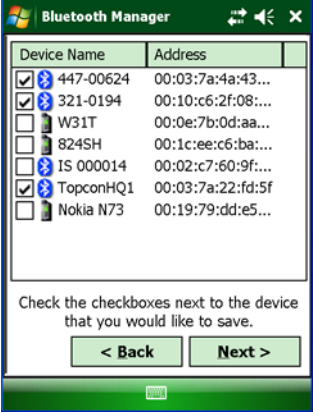

Description	Screen								
<p>Pairing</p> <p>This screen displays when the GRS-1 is in pairing mode, and it accepts a pairing request initiated by a remote device.</p>									
<p>Bluetooth Devices</p> <p>This screen displays the List of Favorite Devices. If you do not see a device that you are looking for on this list, then you can tap Find to search for it.</p>	 <table border="1" data-bbox="497 760 811 1166"> <thead> <tr> <th>Device Name</th> <th>Address</th> </tr> </thead> <tbody> <tr> <td>TopconHQ1</td> <td>00:03:7a:22:fd:5f</td> </tr> <tr> <td>321-0194</td> <td>00:10:c6:2f:08:d5</td> </tr> <tr> <td>447-00624</td> <td>00:03:7a:4a:43:85</td> </tr> </tbody> </table>	Device Name	Address	TopconHQ1	00:03:7a:22:fd:5f	321-0194	00:10:c6:2f:08:d5	447-00624	00:03:7a:4a:43:85
Device Name	Address								
TopconHQ1	00:03:7a:22:fd:5f								
321-0194	00:10:c6:2f:08:d5								
447-00624	00:03:7a:4a:43:85								

Table 5-1. BTManager Screens (Continued)

Description	Screen
<p>About BTManager</p> <p>This screen displays version and copyright information for BTManager.</p>	

Working with Bluetooth Manager

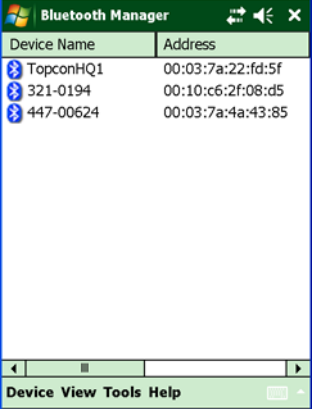
Before the GRS-1 can pair with another Bluetooth-enabled device, it must discover which devices are available within your coverage area. You can use the Device Discovery wizard to search for any Bluetooth-enabled device within range or a particular type of device, and then save the device(s) to your Bluetooth Devices folder for future connections.

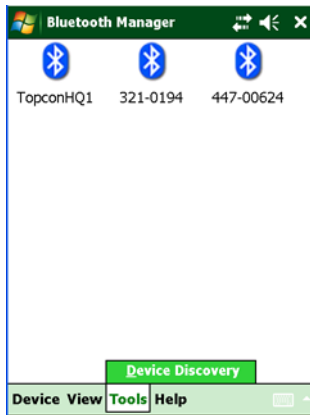

Figure 5-2. List of Favorite Devices

Discovering Devices

To discover other Bluetooth-enabled devices within your coverage area.

1. Tap **Tools** ▶ **Device Discovery**.

The *Discovery Wizard* appears (Figure 5-3).



Figure 5-3. Discovery Wizard

2. Tap **Next** to display a list of device types.

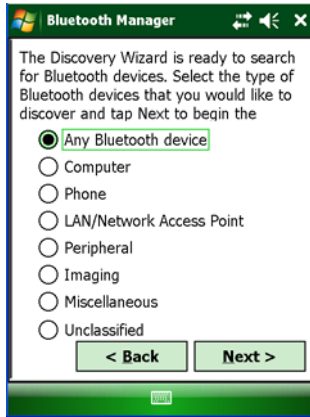

Figure 5-4. Device Categories

3. Choose a type of device to discover, and tap **Next**.

The *Discovery Wizard* searches for Bluetooth-enabled devices in your coverage area and displays the icons of the devices it detects on the *Device List*.

As device names and addresses are retrieved, the *Device List* updates with detailed information (Figure 5-5 on page 5-8).

Once the *Device List* is populated, you can add any device from this list to the *List of Favorite Devices*.



Only up to nine devices can be discovered at a time. If you select the “Any Bluetooth device” option and the device you want is not displayed in the *Device List* (Figure 5-5 on page 5-8), then select a more specific category to narrow the range of the devices you want to discover.

Adding to the List of Favorite Devices

The *Device List* displays all discovered Bluetooth-enabled devices in your coverage area.

To add a device from the Device List to the *List of Favorite Devices*:

1. Select a device, and tap **Next**. You can choose more than one device.

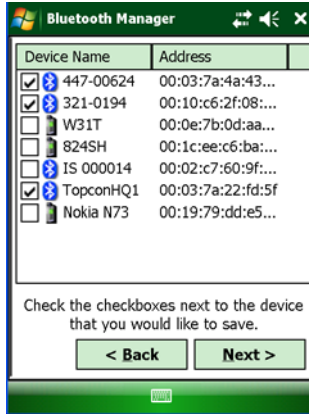

Figure 5-5. Select Device(s)

A confirmation message appears when the devices are successfully added to the *List of Favorite Devices*.

- 2. Tap **Finish** to exit the *Wizard* and display the *List of Favorite Devices*.

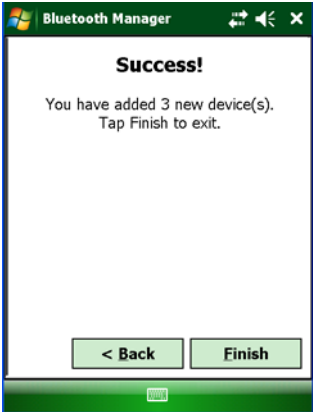

Figure 5-6. Devices Added

To save time, you can save Bluetooth-enabled devices on the *List of Favorite Devices*, so you do not have to rediscover it. You can view devices by icon and name or by name and address.



Figure 5-7. List of Favorite Devices

To display the list of devices by name and address, tap **View ▶ Details**.

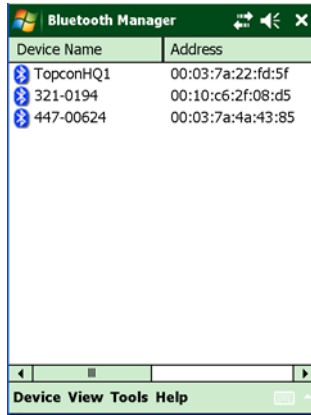

Figure 5-8. Details on Bluetooth Devices

Viewing Device Properties

To view the properties of a device, select the device in the *List of Favorite Devices* (Figure 5-7 on page 5-9), and tap **Device ▶ Properties**.

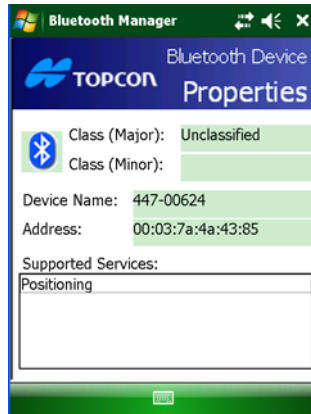

Figure 5-9. Bluetooth Device Properties

The *Bluetooth Device Properties* screen displays major and minor class identifiers, the name, and address of the selected device.

Deleting a Device from the List

To delete a device from the *List of Favorite Devices*:

1. Select the device, and tap **Device ▶ Delete**.
A confirmation message appears.
2. Tap **Yes** to delete the device.

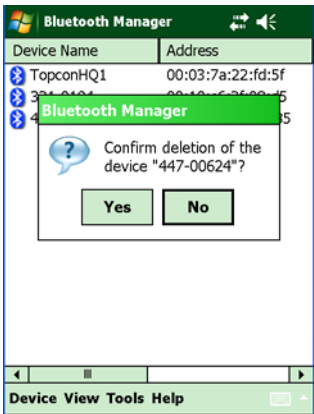

Figure 5-10. Deleting a Device

Setting Device Preferences

The *My Bluetooth Device* screen (Figure 5-11 on page 5-12) displays information about the internal GRS-1 Bluetooth module. The preferences you set on this screen determine how your GRS-1 pairs with and connects to remote devices.

To access the My Bluetooth Device screen, tap **Device** ▶ **My Bluetooth Device**.



Figure 5-11. My Bluetooth Device

My Bluetooth Device always displays the following information:

- Class (major and minor)
- Name (Other devices use this name to identify the GRS-1.)
- Address

This screen also allows you to enable the following accessibility options:

- *Discoverable*: allows other devices within range to find the GRS-1.
 - It is not necessary to enable this option when initiating a connection from the GRS-1 and for most dial-up networking.
 - When not in use, disable this option manually to save power.
- *Connectable*: allows other devices within range to connect to the GRS-1.
 - It is not necessary to enable this option when initiating a connection from the GRS-1 and for most dial-up networking.
- *Authentication*: authenticates the identity of other devices. Select this option if you want to require a passkey to connect with another Bluetooth enabled device. If either or both devices use

authentication, then a passkey must be entered. Once Authentication is selected, the Passkey can be edited.

- *Encryption*: secures all data sent over Bluetooth.



Typically, Topcon Bluetooth-enabled GPS receivers do not require a PIN upon connection. If it is necessary, however, the PIN (up to 16 characters) can be set for a Topcon GPS receiver by BTCONF, the Topcon Bluetooth module configuration program.



Topcon Total Stations require a PIN on connection. Typically, the PIN value is set to “1111”. This value can be changed.

- *Service Mode*: BTManager allows the GRS-1 to connect with other Bluetooth-enabled devices using serial port or dial-up services. The connecting device needs to support the service selected:
 - SPP (Serial Port Profile): provides serial port connection with peripheral Bluetooth-enabled devices, including GPS receivers which normally do not require authentication.
 - DUN (Dial-up Networking Profile): provides a standard to access dial-up services over Bluetooth. The most common scenario is using a mobile phone as a modem.

Pairing Bluetooth Devices

The Pairing Mode allows a remote Bluetooth-enabled device to initiate a request to pair with the GRS-1. If the Pairing Mode option is activated, then the GRS-1 switches to Pairing Mode for two minutes. During this two-minute period, any remote device can attempt to pair with it.

The GRS-1 accepts the first pairing request if the security settings on the remote device match the GRS-1 security settings. You do not need to activate the Pairing Mode option if the GRS-1 initiates the pairing request.

To activate Pairing Mode, tap **Device ▶ Pair**.

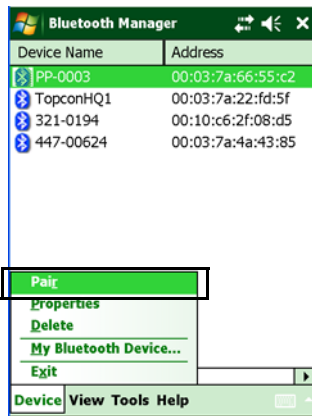

Figure 5-12. Device Menu - Pairing Enable

The *Pairing* screen appears, displaying how much time is left to pair with another device.



Figure 5-13. Pairing Mode

Once the two minutes expires, a message appears stating if the pairing succeeded or failed.

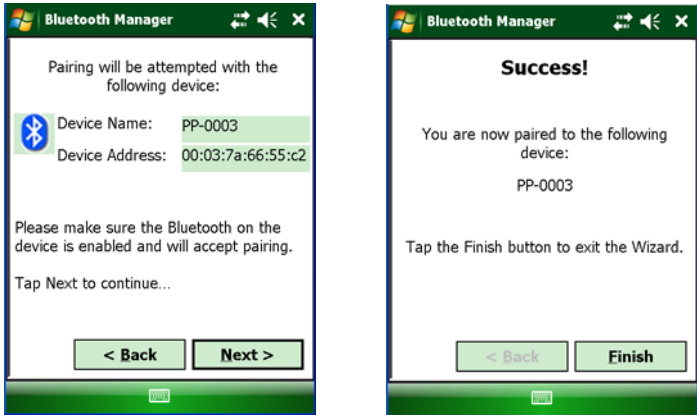

Figure 5-14. Pairing Confirmation

For information about connecting Bluetooth Devices, see “Connecting the GRS-1 and a Bluetooth Device” on page 3-4.

For information about troubleshooting Bluetooth error messages, see “Bluetooth Problems” on page 7-8.

TPS Connection Manager

TPS Connection Manager is Topcon's tool that comes on GRS-1 field controller to setup the internal GSM modem for new network connections in Windows Mobile 6.1.

The tool includes the following functionality:

- Power on the modem and dial based on settings.
- Define the settings for new network connection.
- Power on the GPS receiver.

To run the tool, tap the TPS Connection Manager start icon in the lower right corner of the Windows Mobile screen that opens upon turning the GRS-1 on.

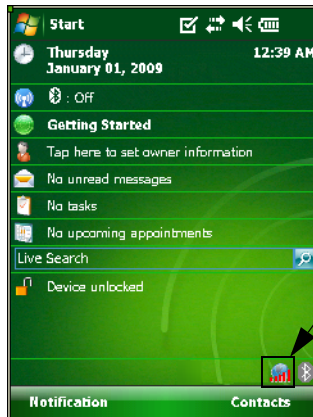

TPS
Connection
Manager Icon

Figure 6-1. Start TPS Connection Manager

Tapping the TPS Connection Manager icon brings up the Main Menu.

Main Menu

The Main Menu displays the menu to access the main options available in the TPS Connection Manager.

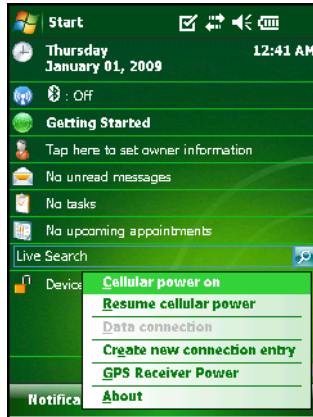

Figure 6-2. Main Menu

- *Cellular power on* – turns on the cell phone power.
- *Resume cellular power* – if this Resume function for the internal GSM is ON (checked with a tick), the GSM power state is automatically restored when the GRS-1 is turned on.
- *Data connection* – sets up network connections to the best available for “My ISP”. It is grey out when the GSM power is OFF.
- *Create new connection entry* – adds new network connections.
- *GPS Receiver Power* – turns on the GPS receiver power.
- *About* – this will show the TPS Connection Manager version.

Create New Connection

When selected, the *Create new connection entry* option will open the dialog to enter settings for a new network connection.

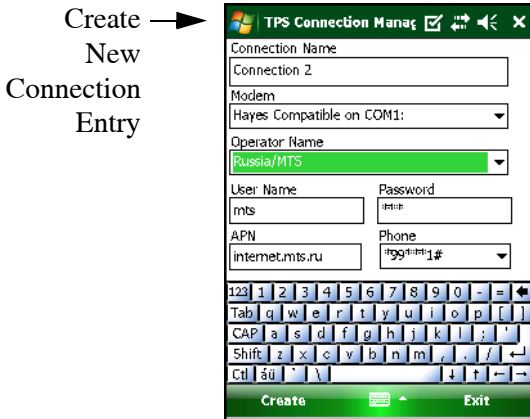

Figure 6-3. Create New Connection Entry

- *Connection Name* – the new connection name.
- *Modem* – selects the modem type from the predefined list. The default selection is preferable.
- *Operator Name* – selects the operator from the predefined list.
- *User Name, Password, APN, Phone* – these will set the user name, password, Access Point Name (APN) and phone dial number to log on to the remote network. The dial number can be edited using the current input panel.
- **Create** – tap to create the new connection. The successful message will display (Figure 6-4 on page 6-3).
- **Exit** – tap to close the screen.



Figure 6-4. Connection Created

Tap OK to close the message and return to the main menu.

Cellular Power On

You need to turn on the cell phone power to dial to the Internet.

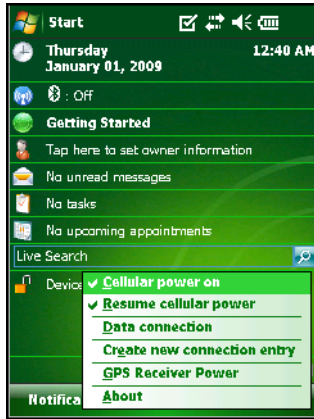

Figure 6-5. Cellular Power On

- *Cellular power on* – check mark this item to turn the GSM on. Note that the Data Connection option becomes available.
- *Resume cellular power* – check mark this option to have the GSM power turned on after a soft reset or switching the GRS-1 off.

Data Connection

This option is used for dialing the cell phone to reach the Internet. The Data Connection option is disabled if the GSM power is turned off.

Note that, if ActiveSync connection is established and the PC has an internet connection, then this connection will be selected.

The TPS Connection Manager creates new connections for “My ISP” predefined “network”. When the user wants to connect to the Internet, Windows Mobile connection manager automatically selects the best available connection from dial-up connections to an Internet Service Provider.

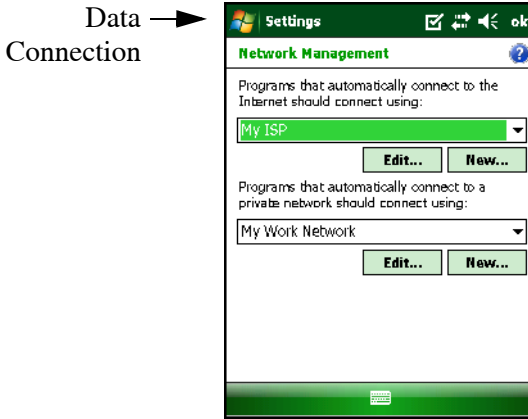



Figure 6-6. My Internet Service Provider Connection

You can check that the connection is established if you tap the status  icon on the top of the screen. Tapping this arrows status icon brings up a screen to view network status. To check or modify the settings of the created network connection, you can use standard Windows Mobile interface:

1. Go to Settings on the Windows Mobile screen.

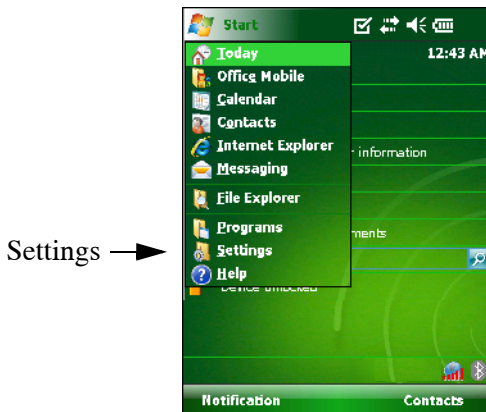

Figure 6-7. Settings

2. Select the Connections tab and then the Connections icon.

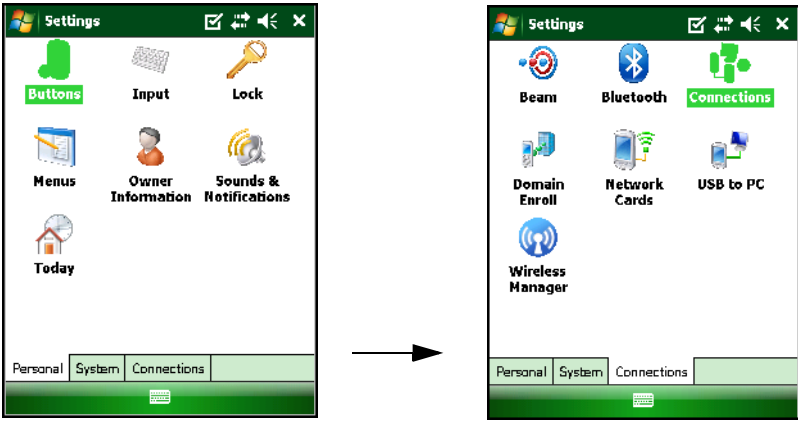

Figure 6-8. Connections

3. You will see “My ISP” connections. If there is no “My ISP” network listed, then you will need to open the Advanced tab and select “My ISP” as an active network.



Figure 6-9. Settings - My ISP

You can also open the Internet Explorer on the Windows Mobile to check on the Internet availability (Figure 6-10 on page 6-7).

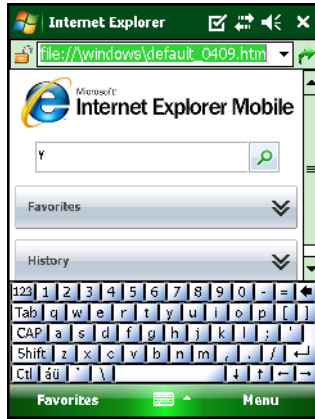

Figure 6-10. Internet Explorer

GPS Receiver Power

Check mark the *GPS Receiver Power* option to turn on the GPS receiver in the GRS-1 system.

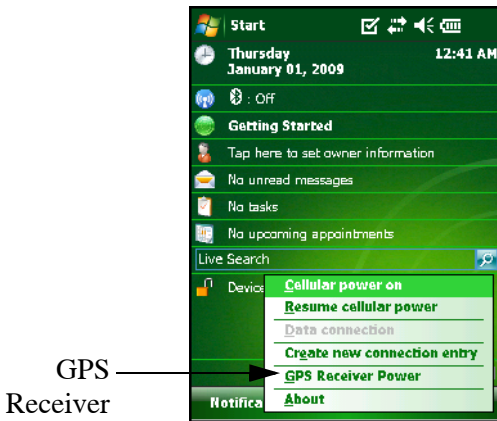

Figure 6-11. GPS Receiver Power

About the Tool

Select the About option from the main menu to view information about the TPS Connection Manager version.

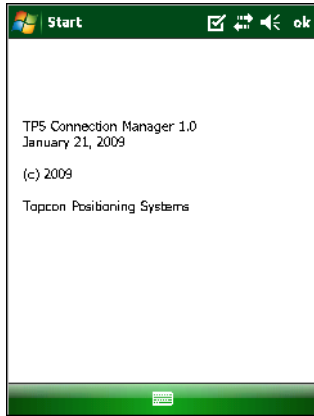

Figure 6-12. About TPS Connection Manager

Troubleshooting

This chapter will help you diagnose and solve some common problems you may encounter with the GRS-1.



Do not attempt to repair equipment yourself. Doing so will void your warranty and may damage the hardware.

Check This First!

Before contacting Topcon support, check the following:

- If software is unresponsive, perform a software reset. See “Resetting the Software” on page 7-3 for details.
- Check all external connections (cable and wireless).
- Check all power sources for drained batteries or incorrectly connected batteries/cables.
- Check that the most current software is downloaded onto the GRS-1, and the most current firmware is loaded into the receiver. Check the TPS website (www.topconpositioning.com) for the latest updates.

Then, try the following:

- Reset the hardware. See “Resetting the Hardware” on page 7-4.
- Restore default settings for the Bluetooth module and GPS+ receiver. See “Restoring Bluetooth Module Defaults” on page 7-4 for details.
- Clear the SDRAM (remove the battery).

If the problem persists, see the following sections for other solutions.

Troubleshooting Quick List

To reset the software, see “Resetting the Software” on page 7-3.

To reset the hardware, see “Resetting the Hardware” on page 7-4.

For power problems:

If “The GRS-1 does not power up” see page 7-6.

For general GRS-1 problems:

If “The GRS-1 is not receiving data (corrections) from an external receiver” see page 7-7.

If “Installed software and other data has been erased” see page 7-8.

For Bluetooth problems:

If “The GRS-1 is no longer connected via Bluetooth” see page 7-8.

If “You cannot connect to another Bluetooth-enabled device” see page 7-8.

Resetting the Software

Only perform a software reset in the following instances:

- To quit all active applications.
- After installing new applications.
- When there is no response after pressing a key or tapping on the screen.

When a software reset is performed, all running applications stop and unsaved data is lost; however, all installed programs and saved data is protected.

To perform a software reset:

1. Disconnect all cables and remove the inserted SD card.
2. Use the stylus pen to lightly press the software reset button at the upper section of the SD card slot (Figure 7-1).

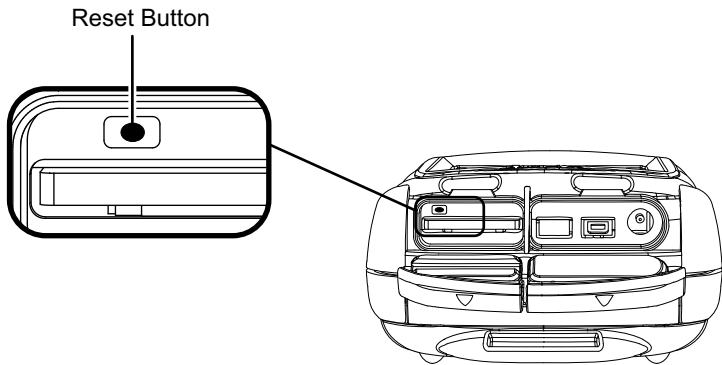

Figure 7-1. Resetting the Software

Restoring Bluetooth Module Defaults

If the Bluetooth module is not performing as expected, try returning the settings to the defaults.

For the Bluetooth module, tap **Reset** on the **Accessibility** tab in BTManager.

Resetting the Hardware

If the GRS-1 does not operate after a software reset or the GRS-1 has become completely unresponsive, then perform a hardware reset. A hardware reset reverts all settings to defaults and erases all applications and data stored in RAM.



A hardware reset erases all RAM data and applications.

Regular backups ensure RAM data and applications can be restored.

To perform a hardware reset (Figure 7-2 on page 7-5):

1. Disconnect all cables and remove the inserted SD card.
2. Simultaneously hold the ENT and ESC buttons while pushing the software reset button with the stylus pen for two or more seconds (Figure 7-2). The unit turns off.
3. Press the **Power** button.

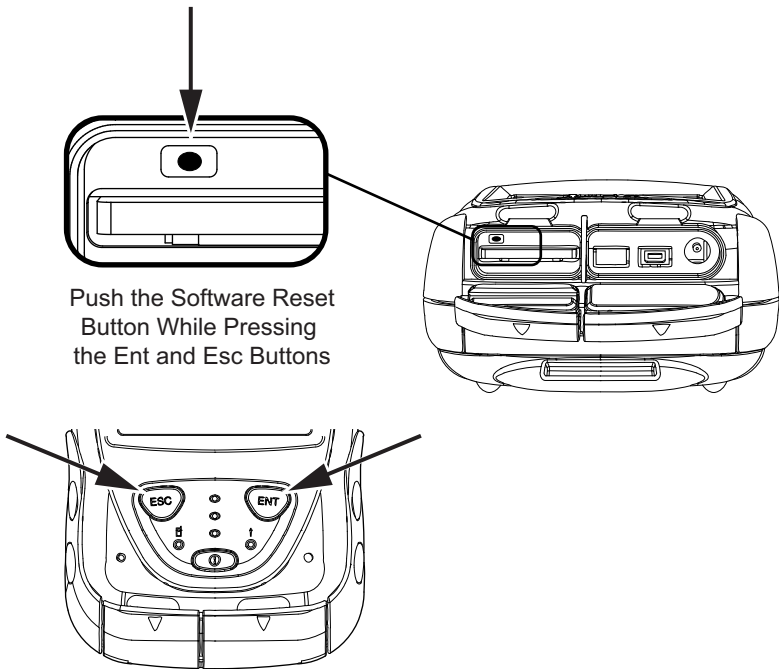

Figure 7-2. Resetting the Hardware

Completely draining the battery performs the same function as a hardware reset.

Format Reset

If the GRS-1 does not operate properly after a hardware reset perform a format reset. When the format reset is performed, the registry information registered by applications to the OS are reset. Data stored by the user is saved; however, the time setting and shortcut information created on the desktop and for program folder is initialized. In such a case, it is necessary to reset the time, and then reinstall applications.



If the equipment does not work normally after the format reset, it needs repair. Please contact your local Topcon dealer or Topcon.

To perform a format reset (Figure 7-3 on page 7-6):

1. Disconnect all cables and remove the inserted SD card.
2. Simultaneously hold the ESC and ENT buttons while pushing the software reset button with the stylus pen for two or more seconds (Figure 7-2 on page 7-5). The GRS-1 turns off.
3. Simultaneously hold the ESC and Power buttons until the GRS-1 restarts (for about 10 seconds).

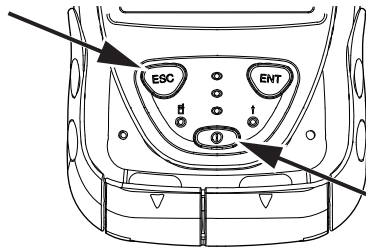

Figure 7-3. Format Reset

Charging/Powering Problems

The GRS-1 does not power up

- ⇒ The batteries may be discharged.
 - Connect the GRS-1 to a grounded outlet to charge the battery. See “Charging the Battery” on page 2-3.
 - Insert a fully charged battery. See “Installing the Battery” on page 2-2.
- ⇒ The charging cable may be disconnected or damaged.

Check that the cable is securely connected and undamaged.

- ⇒ The GRS-1 may have a defective charger or defective internal battery.

If, after changing the battery or connecting an external power source, the GRS-1 still does not power up, contact TPS Customer Support for advice. See “Obtaining Technical Support” on page 7-10.

GRS-1 Problems

The following are some of the most commonly encountered problems with the GRS-1.

The GRS-1 is not receiving data (corrections) from an external receiver

- ⇒ Check the Bluetooth LED. The LED will be blue when a connection has been established.
- ⇒ Check if BTManager was closed manually.

If BTManager was closed manually (tapping the close button on the title bar), the port used for communication between the GRS-1 and an external device will be disconnected from the Bluetooth module.

1. Open BTManager and check the Bluetooth Indicator:

- Red – no connection between BTManager and the Bluetooth module.
- White – a connection between BTManager and the Bluetooth module has been established.
- Green – via a serial port, a connection between the GRS-1 and an external Bluetooth-enabled device has been established.

2. If needed, select the device to connect to, and tap **Connect**.

For more information, see “Connecting the GRS-1 and a Bluetooth Device” on page 3-4.

Installed software and other data has been erased

- ⇒ The battery in the GRS-1 has been completely drained or a hardware reset has been performed.

Reinstall all software. See “Installing Software” on page 2-9 and the software manual for details.

Restore data backed up from the CF card.

Bluetooth Problems

The following are some of the most commonly encountered problems with the GRS-1.

The GRS-1 is no longer connected via Bluetooth

- ⇒ Check the Bluetooth LED. The LED will be blue when a connection has been established.

For information about connecting Bluetooth devices, see “Connecting the GRS-1 and a Bluetooth Device” on page 3-4

You cannot connect to another Bluetooth-enabled device

- ⇒ If you encounter an error message while pairing with other Bluetooth-enabled devices, use Table 7-1 to learn which actions to take to correct the error.

Table 7-1. Most Common Errors





Error Message	Action to Take
 <p>The security account database contains an internal inconsistency.</p> <p>File: .\BtDrtApi.cpp Line: 127 Function: BthPairRequest</p>	<ol style="list-style-type: none"> 1. The PIN you entered on the My Bluetooth Device page does not match the PIN you entered on the remote device. Make sure the GRS-1 and the remote device use the same PIN. 2. The Connectable setting was not selected on the remote device or the device was switched off. Make sure the remote device is on and the Connectable check box on the My Bluetooth Device page is selected. 3. The remote Bluetooth device is already being used and it does not support simultaneous Bluetooth connections. Close the connection between the remote device and other device.
 <p>Confirming the condition (the connectable, security) of other devices.</p>	<p>Set the same parameters for authentication and encryption on both devices and try to connect again.</p>
 <p>This operation returned because the timeout period expired.</p>	<ol style="list-style-type: none"> 1. The remote device does not support the Service Mode you selected. On the My Bluetooth Device page, select another Service Mode. 2. There is a critical problem with the Bluetooth module.

Table 7-1. Most Common Errors (Continued)

Error Message	Action to Take
 <p>The specified network resource or device is no longer available.</p>	<p>Another application is using the GRS-1 COM2 serial port. Close the application or release the port. The COM2 serial port is reserved for the Bluetooth Manager.</p>
 <p>The device is not connected.</p>	<p>Port B of the GRS-1 GPS receiver, through which the Bluetooth Manager connects to the Bluetooth module, is not in command mode. Change Port B input mode back to command mode or clear the GRS-1 NVRAM. See the Operator's Manual for more information.</p>

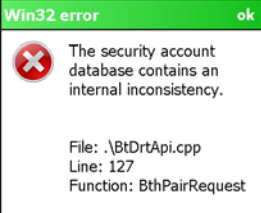
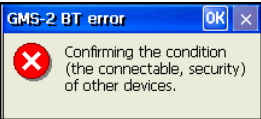
Obtaining Technical Support

If the troubleshooting hints and tips in this Operator's Manual fail to remedy the problem, contact TPS Customer Support.

Before contacting TPS Customer support about any problems with the unit, see "Check This First!" on page 7-1 for some solutions that may fix the issue.

Phone

To contact TPS Customer Support by phone, call:

1-866-4TOPCON (1-866-486-7266)

Monday through Friday

5 am to 5 pm, Pacific Time

E-mail

To contact TPS Customer Support via e-mail, use one of the following electronic mail addresses (Table 7-2).

Table 7-2. Technical Support E-mail

For Questions Related To...	Use...
Hardware (receivers, antennas, firmware)	hardware@topcon.com
GPS+ and 3DMC	psg@topcon.com
OAF	options@topcon.com
RTK	rtk@topcon.com
PC-CDU	pccd@topcon.com
If in doubt...	support@topcon.com



For quick and effective support, provide a detailed description of the problem as described below.

When e-mailing TPS customer support, provide the following information for better, faster service:

1. The device's model and configuration settings.
In TRU (Topcon Receiver Utility), click **File ▶ Receiver Info** and click **Save to file**. Enter a name for the file and save it to your computer. Attach this file to the email.
2. The serial number of the device (located under the battery).
3. The system/hardware specifications for the device(s); such as, operating system and version, memory and storage capacity, processor speed, etc.
4. The symptoms and/or error codes/messages that precede and follow the problem.
5. The activities being tried when the problem occurs. If possible, include the exact steps being taken up to when the error message or other problem occurs.
6. How regularly the problem occurs.

Generally, a customer support representative will reply within 24 hours, depending on the severity of the problem.

Website

The Topcon Positioning Systems website provides current information about Topcon's line of products. The support area of the website provides access to frequently asked questions, configuration procedures, manuals, e-mail support, etc.

To access the TPS website, use: www.topconpositioning.com

Updating the Operating System

This chapter will help you update the operating system (OS) on the GRS-1. Updating the operating system (OS) requires that the internal disk is formatted as part of the process which results in the complete loss of all files, registry settings, and user installed programs.



Formatting the internal disk results in the complete loss of all files, registry settings, and user installed programs.

Prior to updating the OS of the GRS-1, back up all registration codes, user data, TopSURV jobs, or any other data that is stored on the internal memory. Anything that is not part of the original OS will be erased and will not be recoverable.

Required Equipment

The following equipment is required to update the operating system.

- GRS-1
- GRS-1 Power Supply
- Operating System Installation File (GMSXWM.ROM)
- SD Card
- PC with ActiveSync Installed (for installing applications, e.g. TopSURV)
- GRS-1 USB Cable

OS Installation File

The OS installation file for the Topcon GRS-1 is titled **GMSXWM.ROM**. This file must be obtained from Topcon prior to proceeding.

Copy the OS installation file onto an SD card.

Format Reset

In order to update the OS, perform the following steps to enter the **Version up** (operating system update) screen.

1. Disconnect all cables and remove the SD card (if inserted).
2. Power on the GRS-1, and remove the battery while it is powered on.
3. When the GRS-1 is off, simultaneously hold the ESC and ENT buttons while pushing the software reset button with the stylus pen for two or more seconds (Figure 8-1 on page 8-3). The GRS-1 turns off.
4. Release the buttons.

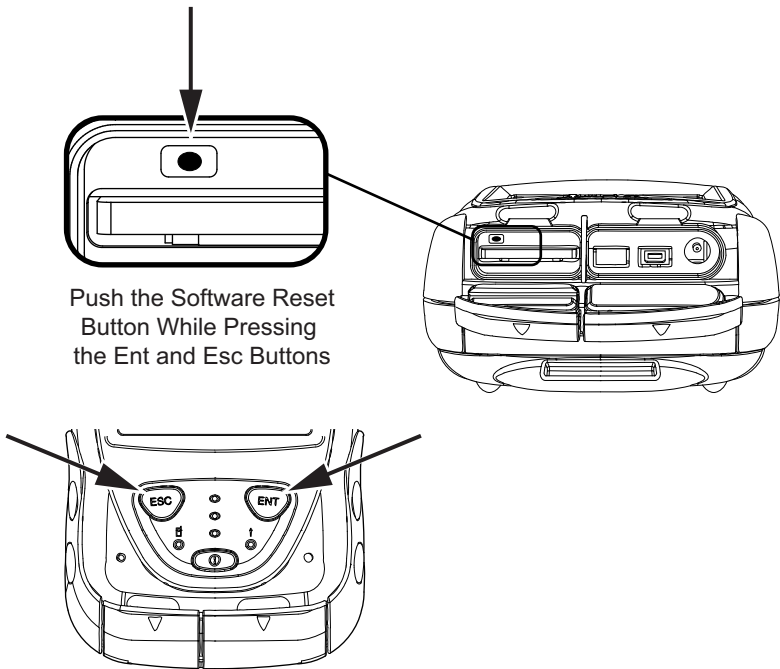

Figure 8-1. format Reset

5. Simultaneously hold the ESC, Power, and Reset buttons until a black screen appears with text at the bottom that reads **DIAG start**, then release the buttons.

After **DIAG start** flashes on the screen, the **Version up** screen displays (Figure 8-2).

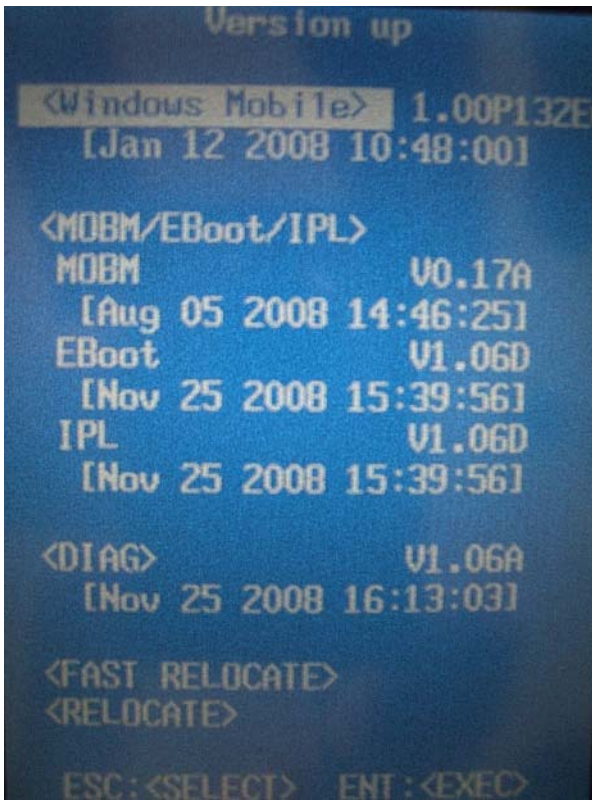

Figure 8-2. Version Up Screen

Installing the OS

1. Insert the SD card that contains the OS installation file.
2. Attach the external power supply. If you lose power during the OS update, the GRS-1 could become dysfunctional.
3. With **Windows Mobile** selected, press the ENT button.
4. Once the screen turns green to signify that the update is complete, press the ENT button as instructed.

5. Finally, press and hold ESC and POWER until the GRS-1 splash screen appears. This takes about 10 seconds.
6. Release the buttons and wait for the screen calibration process to display. It takes about 30 seconds for the device to reboot.

Troubleshooting

If the GRS-1 hangs at the GRS-1 splash screen indefinitely after an OS update, follow the steps below.

1. Perform a format reset as shown in “Format Reset” on page 8-2 to enter the **Version up** screen.
2. Attach the external power supply to the GRS-1.
3. Select the **RELOCATE** option in the **Version up** screen (Figure 8-2).
4. Press the ENT button.
5. This process will take a significant amount of time to complete. Once it is complete, insert the SD card that contains the OS installation file and install as outlined in “Installing the OS” on page 8-4.

Installing Applications

After the OS update is complete, reinstall and register all applications.

Specifications

The GRS-1 is a 72-channel GPS/GLONASS Dual Frequency receiver integrated with an internal computer and Windows Mobile operating system with touch screen, a digital camera, a Bluetooth® wireless technology module, a Wireless LAN module, an electronic compass, and an SD card slot. The portable design and product integration allows this device to be a fully-functional, productive tool at any job.



Performance specifications assume a minimum of 6 GPS satellites above 15 degrees in elevation and adherence to the procedures recommended in this manual.



In areas of high multipath, during periods of large PDOP, and during periods of increased ionospheric activity, performance may degrade.



Use robust checking procedures in areas of extreme multipath or under dense foliage.

GRS-1 Specifications

The following sections provide specifications for the GRS-1 and its internal components.

General Details

Table A-1 table lists the receiver's general specifications.

Table A-1. GRS-1 General Specifications

Physical	
Enclosure	Polycarbonate
Color	Topcon Yellow and Topcon Grey
Dimensions	W:93 x H:215 x D:53 mm
Weight	0.77 kg (with battery)
Antenna	Internal GG
Battery	Internal, rechargeable/replaceable Backup, replaceable
Controller	Integrated; uses Windows Mobile 6.1 Classic operating system
Keys (buttons)	Three keys: Power – On/Off ENT – applies settings, numerical values, and records points; shows Windows Start menu ESC – exits from the current screen or function
LEDs	Three LEDs: Bluetooth/Wireless LAN – indicates Bluetooth Wireless LAN connection status Cell Phone – indicates Cell Phone connection status Charge – indicates charge level
Environment	
Operating temperature	-20 C° to +50 C° with batteries -10 C° to +50 C° using camera
Storage temperature	-30 C° to +60 C° with batteries

Table A-1. GRS-1 General Specifications (Continued)

Waterproof	IP66 at closing all connector caps. IPX4 (Weatherproof) at connecting external antenna cable.
Power	
Internal battery	Li-ion, 2500 mAh 7.4V; replaceable (BT-66Q)
Operating time	No less than 3.5 hours with GPS and cell phone use No less than 4 hours with GPS use No less than 9 hours without GPS and cell phone use
External power	1 port
Input voltage	8 to 15 V DC (for work) 10 to 15 V DC (for charge battery)
Output	12 V - 3 A
Consumption	5.3 W (with Windows Mobile and GPS and GSM)
Battery charger	Connect the AC adaptor to charge the power port. Available run charge when connected to a portable external source
Charging time	within 5 hours for full charge
Charging Temperature	0°C to 40°C
On-board	Backup battery (CR2032) for timekeeping; replaceable button-type battery; 8–10 years normal operation
Communication	
Serial port	Port A of GPS+ board Baud rate = 460800, 230400, 115200, 2400, 1200, 600, 300 Flow control = RTC/CTS Length= 7, 8 (default) Stop bit= 1 default, 2 Parity= None (default), Odd, Even
Bluetooth	Version: Bluetooth standard 1.2; Class 2; Profile: SPP, DUP

Table A-1. GRS-1 General Specifications (Continued)

Wireless LAN	<p>Transmission specifications: IEEE802.11b/g</p> <p>Transmission method: Direct sequence spread spectrum (DS-SS) communication</p> <p>Access method: Infrastructure mode, Ad hoc mode</p> <p>Security: WEP(128/64bit), TKIP</p> <p>Frequency range: 2.4GHz (2,412~2,462MHz) (1~11ch)</p> <p>Transmission output: 30mW</p> <p>Transmission distance: 10m (In good visibility)</p>
USB	Version 1.1 (mini B)
Cell Phone Modem	<p>Type: GSM/GPRS/EDGE CDMA for US WCDMA for Japan GSM/GPRS/EDGE/WCDMA</p> <p>Protocol: GPRS, EDGE, CDMA, WCDMA</p> <p>Frequency: Quad Band 850,900,1800,1900MHz, CDMA800,1900MHz, WCDMA,2100MHz</p>
Connectors and Slot	
Serial port	1 port for communication with the GMS+ board (port A); small connector
USB port	1 port for Windows Mobile; type B mini ver 1.1; connect to PC using ActiveSync
External power port	1 port; DC Jack type A; for connecting the AC adaptor or external battery
External antenna connector	Lemo connector (EPS.01.250.DLN); 5 VDC output to external antenna
SD card slot	1 slot for memory storage and I/O
Windows Mobile	
Processor	Marvel PXA320
Processor speed	806MHz
Operating System	Microsoft Windows® Mobile 6.1 Classic
Digital Camera	
Pixel	2M (UXGA...1600x1200)

Table A-1. GRS-1 General Specifications (Continued)

Sensor element	1/4 inches color C-MOS sensor
Angle of View	53°x 40°
F number	3.0
Focus Range	90 cm to infinity (normal mode), 5 to 10 cm (macro mode)
Zoom	Digital zoom x2, x4, x8
Digital Compass	
Axis	Three (X,Y,Z)
Azimuth angle accuracy	+/-8 degree (in level after calibration)
Inclinometer	
Axis	Two (X,Y)
Angle range	+/- 30 degrees
Tilt angle accuracy	+/- 2 degrees (with reference to optical axis of distance meter)
LCD Display	
Size	640x480 VGA (portrait/landscape) 3.7 inch color TFT transmissive type
Backlight	LED
Touch screen	Resistive touch screen; passive
Audio	
Speaker	Mono
Microphone	Mono
Memory	
ROM	1 GB (NAND Flash Memory)
RAM	256 MB (DDR2 SD RAM)
Connectors and Slots	

Table A-1. GRS-1 General Specifications (Continued)

Serial port	1 port for communication with the GMS+ board (port A); small connector
USB port	1 port for Windows Mobile; type Mini-B ver. 1.1; connect to PC using ActiveSync or Device Center
External power port	1 port; DC jack type A; for connecting the AC adaptor or external battery
SD card slot	1 slot for memory storage and I/O up to 2GB FAT16 format supported (SDHC cards are not currently supported)
External antenna port	Lemo FLS.00.250connector; 5 VDC output to external antenna

GPS Details

Table A-2 lists the GPS board’s general specifications.

Table A-2. GPS Board Specifications

Tracking Specifications	
Tracked Signals	GPS/GLONASS, L1 C/A Code & Carrier, GPS L2C WASS/EGNOS/MSAS
Receiver Type	G – GPS L1 GD – GPS L1/L2 GGD – GPS/GLONASS L1/L2
Standard Channels	72
Cold Start	< 30 sec
Warm Start	< 10 sec
Reacquisition	< 1 sec
Survey Accuracy	
Static	For L1 – H: 3mm + 0.8ppm (x baseline length); V: 4mm + 1.0ppm (x baseline length) For L1 +L2– H: 3mm + 0.5ppm (x baseline length); V: 5mm + 0.5ppm (x baseline length)

Table A-2. GPS Board Specifications (Continued)

Kinematic, RTK	For L1/L1 +L2 – H: 10mm + 1.0ppm (x baseline length); V: 15mm + 1.0ppm (x baseline length)
DGPS	Post processing/RTCM: typically less than 0.5m (RMS)
Other (GPS)	
Real time data format	RTCM 2.3, 3.0; CMR, CMR+; TPS
NMEA	NMEA 2.2, 2.3, 3.0
Output rate	Up to 10 Hz

Bluetooth Details

Table A-3 lists the GPS board's general specifications.

Table A-3. Bluetooth Specifications

Transmission	
Version	Bluetooth® 1.2
Method	Frequency hopping spread spectrum (FH-SS) communication
Distance	5m (in good visibility) ^a
Speed	1 Mbps (max.)
Other (Bluetooth)	
Modulation Method	GFSK
Antenna	Internal Chip Antenna
Frequency Range	2.4 GHz (2,402 - 2,480 MHz) (0-78 ch)
Corresponding Profile	SPP, DUN

- a. Transmission distance will be affected by environmental factors. Radio wave distance may be narrowed near reinforced concrete buildings and large metallic furniture.

Connector Specifications

The GRS-1 has one antenna connector for radio transmission/reception and three port connectors for power and data upload/download.

Serial Connector

The serial connector (Figure A-1) is a sealed receptacle, 5 pin, port. This connector is configured as port A of the internal GPS receiver.

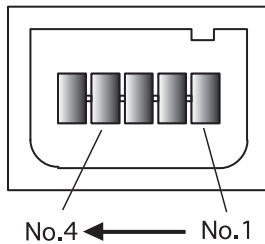

Figure A-1. Serial RS232 Connector

Table A-4 gives the serial port's pin specifications.

Table A-4. Serial Pin Specifications

Number	Signal Name	Dir	Details
1	TXD	O	Clear to send
2	RXD	I	Request to send
3	GND	-	Signal ground
4	GND	-	Signal ground
5	-	-	Not used

USB Connector

Rimmed in yellow, the USB connector is a sealed receptacle, 4 pin TPS cable connector (Figure A-2).

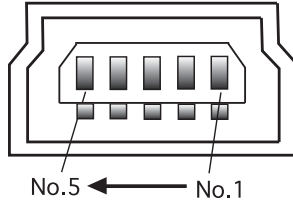

Figure A-2. USB Connector for GGD Options

Table A-5 gives the USB connector specifications.

Table A-5. USB Specifications

Number	Signal Name	Dir	Details
1	VDD	P	Bus power input
2	V-	I/O	Data minus
3	V+	I/O	Data plus
4	-	-	Not used
5	GND	-	Ground

Safety Warnings

General Warnings



TPS receivers are designed for survey and survey related uses (that is, surveying coordinates, distances, angles and depths, and recording such measurements). This product should never be used:

- Without the user thoroughly understanding this manual.
- After disabling safety systems or altering the product.
- With unauthorized accessories.
- Without proper safeguards at the survey site.
- Contrary to applicable laws, rules, and regulations.
- Used near flammable gas, liquid matter, or in a coal mine.



TPS receivers should never be used in dangerous environments. Use in rain or snow for a limited period is permitted.



To avoid electric shock, do not connect or disconnect equipment with wet hands.

Battery Pack Warnings



Never attempt to open the casing of the removable battery! Lithium-Ion batteries can be dangerous if mishandled!



Do not incinerate or heat battery above 212° fahrenheit (100° celsius). Excessive heat can cause serious damage and possible explosion.



Tampering with the batteries by end users or non-factory authorized technicians will void the battery's warranty.

- Do not attempt to open the battery pack or replace it.
 - Do not disassemble the battery pack.
 - Do not charge in conditions different than specified.
 - Do not use other than the specified battery charger.
 - Do not short circuit.
 - Do not crush or modify.
 - Do not cover the charger while it is charging the battery.
 - Do not use a wet battery or charger.
-



Do not allow skin or clothing to come into contact with acid from the batteries. If this does occur, then wash off with water and seek medical advice.



Do not touch the charger, AC-DC converter or a heated part of the device for a long period while charging the battery. There is a risk of low-temperature burn.

Usage Warnings



If this product has been dropped, altered, transported or shipped without proper packaging, or otherwise treated without care, erroneous measurements may occur.

The owner should periodically test this product to ensure it provides accurate measurements.

Inform TPS immediately if this product does not function properly.



Only allow authorized TPS warranty service centers to service or repair this product.

Regulatory Information

The following sections provide information on this product's compliance with government regulations for use.

FCC Compliance

The Federal Communication Commission Radio Frequency Interference Statement includes the following paragraph:

This equipment has been tested and found to comply with the limits for a Class B digital device, pursuant to Part 15 of FCC Rules. These limits are designed to provide reasonable protection against harmful interference in a residential installation. This equipment generates, uses, and can radiate radio frequency energy. If not installed and used in accordance with the instructions, it may cause harmful interference to radio communications. However, there is no guarantee that interference will not occur in a particular installation. If this equipment does cause harmful interference to radio or television reception, which can be determined by tuning the equipment off and on, the user is encouraged to try and correct the interference by one or more of the following measures:

- Reorient or relocate the receiving antenna.
- Increase the distance between the equipment and the receiver.
- Connect the equipment to outlet on a circuit different from that to which the receiver is connected.
- Consult the dealer or an experienced radio/TV technician for help.

Any changes or modifications not expressly approved by the party responsible for compliance could void the user's authority to operate the equipment.

Federal Communication Commission Declaration of Conformity (DoC) Statement



Model No: GRS-1

Trade Name	Topcon
Responsible Party	Topcon Positioning Systems, Inc.
Address	7400 National Drive, Livermore, CA 94550
Telephone No	925-245-8300

Industry Canada (IC) Regulatory Information

This device complies with RSS 210 of Industry Canada.

Operation is subject to the following two conditions:

- (1) This device may not cause interference, and
- (2) This device must accept any interference, including interference that may cause undesired operation of this device.

L' utilisation de ce dispositif est autorisée seulement aux conditions suivantes :

- (1) il ne doit pas produire de brouillage et
- (2) l' utilisateur du dispositif doit être prêt à accepter tout brouillage radioélectrique reçu, même si ce brouillage est susceptible de compromettre le fonctionnement du dispositif.

FCC/IC RF Radiation Exposure Statement For Bluetooth and 802.11b/g

To comply with FCC/IC RF exposure compliance requirements, this device must not be co-located or operating in conjunction with any other antenna or transmitter.

For mobile operation, To comply with FCC/IC RF exposure compliance requirements, a separation distance of at least 20cm must be maintained between the antenna of this device and all persons. This device must not be co-located or operating in conjunction with any other antenna or transmitter.

The installer of this device must ensure that the antenna is located or pointed such that it does not emit RF field in excess of Health Canada limits for the general population; consult Safety Code 6, obtainable from Health Canada's website at www.hc-sc.gc.ca/rpb.

In case that the option GSM/GPRS/EDGE/UMTS/HSDPA Module (FCC ID: QIPHC25, IC: 267W-HC25) is installed To comply with FCC/IC RF exposure compliance requirements, this device has been demonstrated co-location compliance requirement with GSM/GPRS/EDGE/UMTS/HSDPA Module FCC ID: QIPHC25 & IC: 267W-HC25, which is an option for GRS. This device must not be co-located in conjunction with any other antenna or transmitter.

For mobile operation, To comply with FCC/IC RF exposure compliance requirements, a separation distance of at least 20cm must be maintained between the GSM antenna provided together with GSM/GPRS/EDGE/UMTS/HSDPA Module FCC ID: QIPHC25 & IC: 267W-HC25 and all persons as well as between the antenna of this device and all persons.

European Community Declaration of Conformity with R&TTE Directive 1999/5/EC

The following standards were applied: (R&TTE Directive 1999/5/EEC)

- EN 301 489-1 V1.6.1 & EN 301 489-7 v1.3.1 & EN 301 489-17 V1.2.1 & EN 301 489-24 v1.4.1
- EN 300 328 V1.7.1
- EN 301 511 v9.0.2
- EN 301 908-1 & 02
- EN 50371
- IEC 60950-1 & EN 60950-1

The following CE mark is affixed to the device:



To comply with RF exposure compliance requirements, a separation distance of at least 20 cm must be maintained between the antenna of this device and all persons. This device must not be co-located or operating in conjunction with any other antenna or transmitter.

Canadian Emission Labeling Requirements

1. Operation is subject to the following two conditions: (1) this device may not cause interference, and (2) this device must accept any interference, including interference that may cause undesired operation of the device.
2. To reduce potential radio interference to other users, the antenna type and its gain should be so chosen that the equivalent

isotropically radiated power (e.i.r.p.) is not more than that permitted for successful communication.





- This Class B digital apparatus meets all requirements of the Canadian Interference-Causing Equipment Regulations.

Cet appareil numérique de la classe B respecte conform a la norme NMB-003 du Canada.

Declaration of Conformity with Regard to the R&TTE Directive 1999/5/EC

[cs] Český [Czech]	<i>(Topcon Positioning Systems, Inc.)</i> tímto prohlašuje, že tento (<i>GRS</i>) je ve shodě se základními požadavky a dalšími příslušnými ustanoveními směrnice 1999/5/ES.
[da] Dansk [Danish]	Undertegnede (<i>Topcon Positioning Systems, Inc.</i>) erklærer herved, at følgende udstyr (<i>GRS</i>) overholder de væsentlige krav og øvrige relevante krav i direktiv 1999/5/EF.
[de] Deutsch [German]	Hiermit erkläre (<i>Topcon Positioning Systems, Inc.</i>) dass sich das Gerät (<i>GRS</i>) in Übereinstimmung mit den grundlegenden Anforderungen und den übrigen einschlägigen Bestimmungen der Richtlinie 1999/5/EG befindet.
[et] Eesti [Estonian]	Käesolevaga kinnitab (<i>Topcon Positioning Systems, Inc.</i>) seadme (<i>GRS</i>) vastavust direktiivi 1999/5/EÜ põhinõuetele ja nimetatud direktiivist tulenevatele teistele asjakohastele sätetele.
[en] English	Hereby, (<i>Topcon Positioning Systems, Inc.</i>) declares that this (<i>GRS</i>) is in compliance with the essential requirements and other relevant provisions of Directive 1999/5/EC.
[es] Español [Spanish]	Por medio de la presente (<i>Topcon Positioning Systems, Inc.</i>) declara que el (<i>GRS</i>) cumple con los requisitos esenciales y cualesquiera otras disposiciones aplicables o exigibles de la Directiva 1999/5/CE.

[el] Ελληνική [Greek]	ΜΕ ΤΗΝ ΠΑΡΟΥΣΑ (<i>Topcon Positioning Systems, Inc.</i>) ΔΗΛΩΝΕΙ ΟΤΙ (<i>GRS</i>) ΣΥΜΜΟΡΦΩΝΕΤΑΙ ΠΡΟΣ ΤΙΣ ΟΥΣΙΩΔΕΙΣ ΑΠΑΙΤΗΣΕΙΣ ΚΑΙ ΤΙΣ ΛΟΙΠΕΣ ΣΧΕΤΙΚΕΣ ΔΙΑΤΑΞΕΙΣ ΤΗΣ ΟΔΗΓΙΑΣ 1999/5/ΕΚ.
[fr] Français [French]	Par la présente (<i>Topcon Positioning Systems, Inc.</i>) déclare que l'appareil (<i>GRS</i>) est conforme aux exigences essentielles et aux autres dispositions pertinentes de la directive 1999/5/CE.
[it] Italiano [Italian]	Con la presente (<i>Topcon Positioning Systems, Inc.</i>) dichiara che questo (<i>GRS</i>) è conforme ai requisiti essenziali ed alle altre disposizioni pertinenti stabilite dalla direttiva 1999/5/CE.
[el] Ελληνική [Greek]	ΜΕ ΤΗΝ ΠΑΡΟΥΣΑ (<i>Topcon Positioning Systems, Inc.</i>) ΔΗΛΩΝΕΙ ΟΤΙ (<i>GRS</i>) ΣΥΜΜΟΡΦΩΝΕΤΑΙ ΠΡΟΣ ΤΙΣ ΟΥΣΙΩΔΕΙΣ ΑΠΑΙΤΗΣΕΙΣ ΚΑΙ ΤΙΣ ΛΟΙΠΕΣ ΣΧΕΤΙΚΕΣ ΔΙΑΤΑΞΕΙΣ ΤΗΣ ΟΔΗΓΙΑΣ 1999/5/ΕΚ.
[fr] Français [French]	Par la présente (<i>Topcon Positioning Systems, Inc.</i>) déclare que l'appareil (<i>GRS</i>) est conforme aux exigences essentielles et aux autres dispositions pertinentes de la directive 1999/5/CE.
[it] Italiano [Italian]	Con la presente (<i>Topcon Positioning Systems, Inc.</i>) dichiara che questo (<i>GRS</i>) è conforme ai requisiti essenziali ed alle altre disposizioni pertinenti stabilite dalla direttiva 1999/5/CE.
Latviski [Latvian]	Ar šo (<i>Topcon Positioning Systems, Inc.</i>) deklarē, ka (<i>GRS</i>) atbilst Direktīvas 1999/5/EK būtiskajām prasībām un citiem ar to saistītajiem noteikumiem.
Lietuvių [Lithuanian]	Šiuo (<i>Topcon Positioning Systems, Inc.</i>) deklaruoją, kad šis (<i>GRS</i>) atitinka esminius reikalavimus ir kitas 1999/5/EB Direktyvos nuostatas.
[nl] Nederlands [Dutch]	Hierbij verklaart (<i>Topcon Positioning Systems, Inc.</i>) dat het toestel (<i>GRS</i>) in overeenstemming is met de essentiële eisen en de andere relevante bepalingen van richtlijn 1999/5/EG.
[mt] Malti [Maltese]	Hawnhekk, (<i>Topcon Positioning Systems, Inc.</i>) , jiddikjara li dan (<i>GRS</i>) jikkonforma mal-ħtiġijiet essenzjali u ma provvedimenti oħrajn relevanti li hemm fid-Dirrettiva 1999/5/EC.
[hu] Magyar [Hungarian]	Alulírott, (<i>Topcon Positioning Systems, Inc.</i>) nyilatkozom, hogy a (<i>GRS</i>) megfelel a vonatkozó alapvető követelményeknek és az 1999/5/EC irányelv egyéb előírásainak.

<p> Polski [Polish]</p>	<p>Niniejszym, (<i>Topcon Positioning Systems, Inc.</i>) , deklaruję, że (<i>GRS</i>) spełnia wymagania zasadnicze oraz stosowne postanowienia zawarte Dyrektywie 1999/5/EC.</p>
<p> Português [Portuguese]</p>	<p>(<i>Topcon Positioning Systems, Inc.</i>) declara que este (<i>GRS</i>) está conforme com os requisitos essenciais e outras disposições da Directiva 1999/5/CE.</p>
<p> Slovensko [Slovenian]</p>	<p>(<i>Topcon Positioning Systems, Inc.</i>) izjavlja, da je ta (<i>GRS</i>) v skladu z bistvenimi zahtevami in ostalimi relevantnimi določili direktive 1999/5/ES.</p>
<p>Slovensky [Slovak]</p>	<p>(<i>Topcon Positioning Systems, Inc.</i>) týmto vyhlasuje, že (<i>GRS</i>) spĺňa základné požiadavky a všetky príslušné ustanovenia Smernice 1999/5/ES.</p>
<p> Suomi [Finnish]</p>	<p>(<i>Topcon Positioning Systems, Inc.</i>) vakuuttaa täten että (<i>GRS</i>) tyyppinen laite on direktiivin 1999/5/EY oleellisten vaatimusten ja sitä koskevien direktiivin muiden ehtojen mukainen.</p>
<p> Svenska [Swedish]</p>	<p>Härmed intygar (<i>Topcon Positioning Systems, Inc.</i>) att denna (<i>GRS</i>) står i överensstämmelse med de väsentliga egenskapskrav och övriga relevanta bestämmelser som framgår av direktiv 1999/5/EG.</p>

Community of Europe Compliance

The product described in this manual is in compliance with the R&TTE and EMC directives from the European Community.



WEEE Directive

This symbol is applicable to EU member states only.

Following information is only for EU-member states:

The use of the symbol indicates that this product may not be treated as household waste. By ensuring this product is disposed of correctly, you will help prevent potential negative consequences for the environment and human health, which could otherwise be caused by inappropriate waste handling of this product. For more detailed information about the take-back and recycling of this product, please contact your supplier where you purchased the product or consult.



EU Battery Directive

This symbol is applicable to EU member states only.

Battery users must not dispose of batteries as unsorted general waste, but treat properly.



Perchlorate Material – Special Handling May Apply

For more information, see www.dtsc.ca.gov/hazardouswaste/perchlorate

This applies to California, USA only.

Warranty Terms

TPS laser and electronic positioning equipment are guaranteed against defective material and workmanship under normal use and application consistent with this Manual. The equipment is guaranteed for the period indicated, on the warranty card accompanying the product, starting from the date that the product is sold to the original purchaser by TPS' Authorized Dealers.¹

During the warranty period, TPS will, at its option, repair or replace this product at no additional charge. Repair parts and replacement products will be furnished on an exchange basis and will be either reconditioned or new. This limited warranty does not include service to repair damage to the product resulting from an accident, disaster, misuses, abuse or modification of the product.

Warranty service may be obtained from an authorized TPS warranty service dealer. If this product is delivered by mail, purchaser agrees to insure the product or assume the risk of loss or damage in transit, to prepay shipping charges to the warranty service location and to use the original shipping container or equivalent. A letter should accompany the package furnishing a description of the problem and/or defect.

The purchaser's sole remedy shall be replacement as provided above. In no event shall TPS be liable for any damages or other claim including any claim for lost profits, lost savings or other incidental or consequential damages arising out of the use of, or inability to use, the product.

1. The warranty against defects in a Topcon battery, charger, or cable is 90 days.



Topcon Positioning Systems, Inc.

7400 National Drive, Livermore, CA 94550
800-443-4567 www.topconpositioning.com



ISO 9001:2000
FM 60-440

GRS-1 Operator's Manual
P/N: 7010-0926 Rev A 04/09

©2009 Topcon Corporation All rights reserved. No unauthorized duplication.